

Werkzeug-Sortiment mit Werkstattwagen, 349-teilig

95/349QR

Art.-Nr. 98830243

GTIN 4018754363049

Modell 95/349QR



Bezeichnung.

Werkzeug-Sortiment mit Werkstattwagen 95/349QR Schubl.8 anthrazit, RAL 7016
349 tlg.

Eigenschaften.

Top-Features Werkstattwagen

- dreistufiges Sicherheitskonzept:
 - Zentralverriegelung durch seitliches Zylinderschloss mit abklappbarem Schlüssel
 - Einzelverriegelung verhindert unbeabsichtigtes Öffnen während der Fahrt
 - Kippschutz - gleichzeitiges Herausziehen mehrerer Schubladen nicht möglich.
- schwarz lackierter Stahlgriff mit verstärkter Korpusanbindung
- umlaufender Rammschutz mit Aufpralldämpfung
- dicht verschweißte, widerstandsfähige Arbeits- und Ablagefläche
- öl- und säurebeständige, kugelgeführte Leichtlaufräder (Ø 125 mm) mit Fadenschutz zum Schutz der Lager vor Schmutz und Fäden, mit zwei Feststellbremsen
- Papierrollen- und Spraydosenhalterung inklusive
- 8 leicht herausnehmbare Schubladen (schwarz RAL 9005) mit Vollauszug und Kugelhäufigführung
- beidseitige Lochraster für Haken Nr. 8031-8041, z. B. für größere Werkzeuge
- ausrüstbar mit STAHLWILLE Standard- und TCS-Einlagen
- sicher integriert in das Werkzeugeinlagen-Baukastensystem Tool Control System (TCS)

1 Werkstattwagen **Nr. 95/8 A PRO**: 8 Schubladen

Inhalt 349-teilig:

96830303

13 Steckschlüsseleinsätze 1/4" mit Sechskant **Nr. 40**: 4; 4,5; 5; 5,5; 6; 7; 8; 9; 10; 11; 12; 13; 14 mm

12 Steckschlüsseleinsätze lang, mit Sechskant 1/4" **Nr. 40L**: 4; 4,5; 5; 5,5; 6; 7; 8; 9; 10; 11; 12; 13 mm

6 Steckschlüsseleinsätze 1/4" TORX® **Nr. 40TX**: E4; E5; E6; E7; E8; E10

5 Schraubendrehereinsätze INHEX 1/4" **Nr. 44**: 2,5; 3, 4, 5, 6 mm

2 Schraubendrehereinsätze Kreuzschlitz 1/4" **Nr. 44PH**: PH1; PH2

2 Schraubendrehereinsätze 1/4" Kreuzschlitz **Nr. 44PZ**: PZ1; PZ2

8 Schraubendrehereinsätze TORX® 1/4" **Nr. 44KTXB**: T8; T9; T10; T15; T20; T25; T27; T30

3 Gelenk-Steckschlüsseleinsätze 1/4" **Nr. 402**: 6; 8, 10 mm

1 Wobble-Drive-Verlängerung 1/4" **Nr. 405W**: L. 254 mm
3 QuickRelease-Verlängerungen 1/4" **Nr. 408QR**: L. 55; 99; 150 mm
1 QuickRelease-Kardangelenke 1/4" **Nr. 407/1QR**: L. 45 mm
1 flexible Verlängerung 1/4" **Nr. 406**: L. 152 mm
1 Bit-Halter 1/4" **Nr. 412**: L. 25 mm
1 QuickRelease-Feinzahnknarre 1/4" **Nr. 415QR N**: L. 117 mm
1 QuickRelease-Feinzahngelenkknarre 1/4" **Nr. 416QR**: L. 170 mm
4 Steckschlüsseleinsätze TORX® 3/8" **Nr. 45TX**: E8; E10; E12; E14
12 Steckschlüsseleinsätze lang, mit Doppelsechskant 3/8" **Nr. 46**: 10; 11; 12; 13; 14; 15; 16; 17; 18; 19; 21; 22 mm
4 Schraubendrehereinsätze 3/8" für INHEX-Schrauben **Nr. 49**: 6; 7; 8; 10 mm
4 Schraubendrehereinsätze XZN® 3/8" **Nr. 49X**: M5; M6; M8; M10
5 Schraubendrehereinsätze TORX® 3/8" **Nr. 49TX**: T25; T27; T30; T40; T45
13 Steckschlüsseleinsätze mit Doppelsechskant 3/8" **Nr. 45**: 10; 11; 12; 13; 14; 15; 16; 17; 18; 19; 20; 21; 22 mm
13 Steckschlüsseleinsätze mit Doppelsechskant 3/8" **Nr. 456**: 10; 11; 12; 13; 14; 15; 16; 17; 18; 19; 20; 21; 22 mm
1 Steckschlüsseleinsatz lang, mit Doppelsechskant und Gummieinsatz 3/8" **Nr. 4600**: 16 mm-5/8"
1 Zündkerzen-Steckschlüsseleinsatz lang, mit Sechskant und Gummieinsatz 3/8" **Nr. 4606**: 18 mm/ 11/16"
2 Schraubendrehereinsätze INHEX 3/8" **Nr. 1049**: 7; 9 mm
1 Vergrößerungsstück 3/8" **Nr. 409**: 1/4 auf 3/8" L. 25 mm
3 QuickRelease-Verlängerungen 3/8" **Nr. 426QR**: L. 75; 160; 240 mm
1 Wobble-Drive-Verlängerung 3/8" **Nr. 427W**: L. 76 mm
1 QuickRelease-Kardangelenke 3/8" **Nr. 428/1QR**: L. 60 mm
1 QuickRelease-Feinzahnknarre 3/8" **Nr. 435QR N**: L. 193 mm
1 Reduzierstück **Nr. 431**: 3/8 auf 1/4"
1 Vergrößerungsstück **Nr. 432**: 3/8 auf 1/2"
1 Reduzierstück **Nr. 513**: 1/2 auf 3/8"

96830304

6 Steckschlüsseleinsätze TORX® 1/2" **Nr. 50TX**: E12; E14; E16; E18; E20; E24
20 Steckschlüsseleinsätze 1/2" mit Sechskant **Nr. 52**: 10; 11; 12; 13; 14; 15; 16; 17; 18; 19; 20; 21; 22; 23; 24; 26; 27; 28; 30; 32 mm
7 Schraubendrehereinsätze INHEX 1/2" **Nr. 54**: 6; 7; 8; 10; 12; 14; 17 mm
7 Schraubendrehereinsätze 1/2" **Nr. 54X**: M5; M6; M8; M10; M12; M14; M16
8 Schraubendrehereinsätze 1/2" **Nr. 54TX**: T27; T30; T40; T45; T50; T55; T60; T70
1 Wobble-Drive-Verlängerungen 1/2" **Nr. 509W**: L. 52 mm
2 QuickRelease-Steckschlüsselverlängerungen, mit versenktem Kopf 1/2" **Nr. 503QR**: L. 130; 250 mm
1 QuickRelease-Kardangelenke 1/2" **Nr. 510QR**: L. 80 mm
1 Gelenkgriff 1/2" **Nr. 504-2K**: L. 397 mm
1 QuickRelease-Feinzahnknarre 1/2" **Nr. 512QR N80**: L. 265,5 mm
1 Teleskopknarre 1/2" **Nr. 516**: L. 410 - 630 mm
3 IMPACT-Steckschlüsseleinsätze 1/2" **Nr. 51IMP**: 17; 19; 21 mm

96830305

4 Schlitzschraubendreher **Nr. 4622**: 1,0 x 5,5 x 100; 1,2 x 6,5 x 125; 1,6 x 10,0 x 175; 2,0 x 12,0 x 200 mm
1 Kreuzschlitzschraubendreher DRALL+ **Nr. 4630**: PH1
1 Kreuzschlitzschraubendreher DRALL+ **Nr. 4632**: PH3
10 TORX® Schraubendreher **Nr. 4650**: T6; T7; T8; T9; T10; T15; T20; T25; T27; T30
1 Schlitzschraubendreher **Nr. 4724**: 1,0 x 5,5 x 25 mm
1 Kreuzschlitzschraubendreher **Nr. 4734**: PH2
1 x Bit-Ratschenschraubendreher 1/4" **Nr. 4008-1**: L. 250 mm
1 Bit-Ratschenschraubendreher 1/4" **Nr. 4008-2**: L. 95 mm

1 Bit-Box Nr. 1206: 1 Bit-Halter | L. 25 mm: SL4;5;6 mm (2x) | PH1;2;3 (3x) | PZ1;2;3 (3x) | T10;15;20;25;27;30;40 (2x) | T B010;15;20;25;27;30;40 | INHEX 3;4;5 mm | L. 75 mm: SL6 mm | PH2;3 | PZ1;2 | T20;25 | 56-teilig

96830306

2 Sicherungsringzangen für Innenringe **Nr. 6543, 6544:** J2; J21
2 Sicherungsringzangen für Außenringe **Nr. 6545, 6546:** A2; A21
1 Wasserpumpenzange **Nr. 6572:** L. 240 mm
1 Kombinationszange **Nr. 6700:** L. 180 mm
1 Kraft-Seitenschneider **Nr. 6721:** L. 160 mm
1 Telefonzange **Nr. 6730:** L. 200 mm
1 Telefonzange **Nr. 6731:** L. 200 mm
5 Kunststoffschaber **Nr. 10677-10681:** breite, mittlere, schmale, schräge, spitze Klinge
1 Arbeitsleuchte **Nr. 13134:** 500, 300, 100 lm
1 Winkelschraubendreher-Satz Sechskant **Nr. 10767/9:** 1,5; 2; 2,5; 3; 4; 5; 6; 8; 10 mm
1 Flaschenöffner STAHLWILLE: L. 135 mm

96830307

20 Ringmaulschlüssel **Nr. 13:** 6; 7; 8; 9; 10; 11; 12; 13; 14; 15; 16; 17; 18; 19; 21; 22; 24; 27; 30; 32 mm
3 Doppelringschlüssel, offen abgewinkelt **Nr. 24:** 8 x 10; 11 x 13; 12 x 14 mm
15 Ratschenringmaulschlüssel **Nr. 17:** 8; 9; 10; 11; 12; 13; 14; 15; 16; 17; 18; 19; 21; 22; 24 mm

96830308

1 Bremssattelbürste **Nr. 12373:** L. 230 mm
1 Teleskop-Edelstahlspiegel **Nr. 12921M:** L. 178-921 mm
1 Auto-Prüflampe **Nr. 12905:** 6-12 + 24 V
1 Reifenprofil-Messschieber **Nr. 12900/3:** 0-30 mm
1 Messschieber **Nr. 12900:** Messbereich: 150/6 mm/"
2 Magnetheber **Nr. 12600:** 270; 500 g
1 Kabelmesser **Nr. 12320:** 111 mm
1 Präzisions-Fühlerlehre, 13 Blätter **Nr. 11095/13:** 0,05-1,00 mm
1 Hebeleisen **Nr. 11006:** L. 400 mm
1 Dichtungsschaber **Nr. 12718:** L. 265 mm
1 Nylonhammer **Nr. 10956:** 75 Shore
1 Schlosserhammer **Nr. 10961:** 500 g
5 Splinttreiber **Nr. 108:** 3; 4; 5; 6; 8 mm
1 Körner **Nr. 105:** 120 mm
2 Flachmeißel **Nr. 102:** 150; 200 mm
1 Universal-Gripzange **Nr. 6563:** L. 250 mm

Vorteile.

Belastbarer, robuster Werkzeugwagen mit 8 Vollauszug-Schubladen und Zentralverriegelung inkl. 349-teiligem Werkzeug-Sortiment.

Patentiertes QuickRelease-Verriegelungssystem sichert alle Komponenten von der Knarre über die Verlängerung bis zum Steckschlüsseinsatz.

Umfangreiches Kfz-Sortiment mit Feinzahnknarren, Steckschlüsseinsätzen bis 32 mm, Mess- und Prüfwerkzeugen, Schraubendrehern, Zangen u. v. m.

Der strapazierfähige Werkstattwagen 95/8 hat eine statische Belastbarkeit von bis zu 750 kg - die untere Schublade hat dabei eine Traglast von bis zu 45 kg.

Das Werkzeug ist sicher in langlebigen, chemiebeständigen TCS-Einlagen mit präzisen Aussparungen und farblicher Signalfläche integriert.

Produkthighlights.



Komplettlösung für Automotive und Industrie.

Unser umfassendes Werkzeug-Sortiment bietet eine passende Lösung für professionelle Anwendungen im Automotive und im Industriebereich: Ob beim Austausch von Zündkerzen, dem Lösen festsitzender Verschraubungen an Achs- oder Fahrwerkskomponenten, bei elektrischen Prüfungen oder bei Wartungsarbeiten an Maschinen. Es beinhaltet unter anderem Feinzahnknarren mit QuickRelease, Steckschlüsseinsätze in 1/4", 3/8" und 1/2" bis 32 mm, einen vielseitigen Bit-Satz, lange Zündkerzen-Steckschlüsseinsätze, präzise Mess- und Prüfwerkzeuge, eine breite Auswahl an Schraubendrehern und Zangen sowie zahlreiche Spezialwerkzeuge. Damit stellt diese Ausstattung eine verlässliche Basis für alle täglichen Aufgaben in der Werkstatt und im industriellen Umfeld dar.

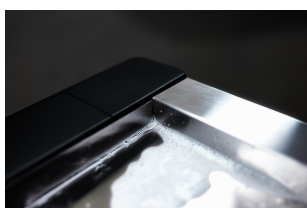

Nimmt es mit allem auf.

Hochwertige Materialien wie die dicht verschweißte Edelstahlwanne mit einer kratzfesten Wabenstruktur sorgen für die STAHLWILLE typische Langlebigkeit und verhindern das Eindringen von Flüssigkeiten in das Wageninnere. Die Arbeitsfläche von 827 x 496 mm eignet sich besonders für Arbeiten an großen Bauteilen. Durch die robuste Konstruktion erreicht der 95 PRO eine statische Belastbarkeit von 750 kg. Die Schubladen können dank Versteifungen mit 30 kg und die unterste Schublade sogar mit 45 kg belastet werden.



Serienmäßige Vollausrüstung.

Ganz gleich ob Papierrollen- und Spraydosenshalter, umlaufender Rammschutz mit Aufpralldämpfung, beidseitiges Lochraster zum Anbringen von Zubehör, Feststellbremsen oder Öl- und säurebeständige Leichtlaufräder (Ø 125 mm) mit Fadenschutz. Unser Werkzeug-Trolley bringt viele Features mit - und das serienmäßig.

Technologien und Leistungsmerkmale.

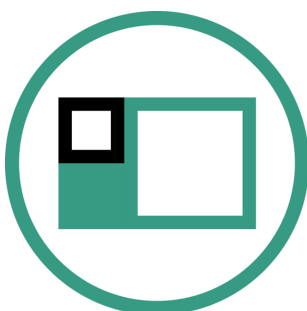

Modular Inlay System

Diese flexible Lösung zur Aufbewahrung von Werkzeugen ermöglicht die individuelle Bestückung der Werkstattwagen und Werkbänke wahlweise mit 1/6, 1/3, 2/3 oder 3/3 Schaumstoffeinlagen.



Tool Control System

Das intelligente Sicherheitseinlagen-Baukastensystem schützt und organisiert das Werkzeug in Werkzeugkoffern, Werkstattwagen und Werkbänken. Zweifarbiges Schaumflächen dienen der schnellen Überprüfung der Vollständigkeit.

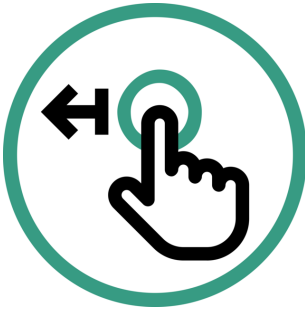

QuickRelease

Die QuickRelease-Sicherheitsverriegelung verhindert ungewolltes Lösen von Steckschlüsseinsätzen und Einsteckwerkzeugen. Diese rasten sicher ein und werden für einen schnellen Werkzeugwechsel erst auf Knopfdruck wieder freigegeben.



High Performance Quality (HPQ®)

Unser HPQ® Werkzeug besteht aus verschleißfestem Hochleistungsstahl, ist dennoch dünnwandig und leicht. Es hält hohen Drehmomenten stand und ist ideal für Arbeiten in beengten Platzverhältnissen, wie bspw. an Turbinen.

Technische Zeichnung.

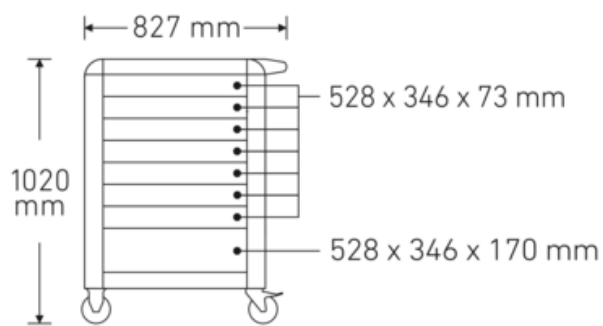
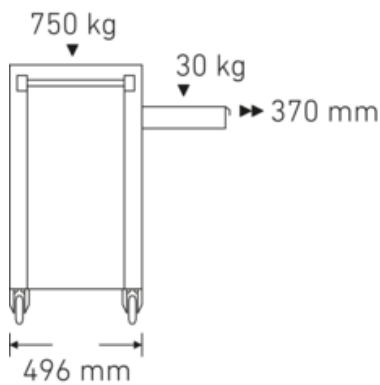

Technische Attribute.

Länge mm (L)	497 mm
Breite mm (b)	823 mm
Höhe mm (h)	1021 mm
Anzahl Schubladen	8
Farbe	anthrazit, RAL 7016
Anzahl Werkzeuge	349 tlg.

Logistikdaten.

Art.-Nr.	98830243
GTIN	4018754363049
Gewicht (g)	101000 g
Volumen (verpackt, dm ³)	652.8 dm ³
Packnorm	1
WEEE/ElektroG	nicht ear-pflichtig
Zolltarifnr.	82060000
Ursprungsland AWR	GERMANY
Ursprungsregion	Nordrhein-Westfalen
Tiefe mm (IFS)	800
Breite mm (IFS)	600
Höhe mm (IFS)	1360
Gewicht (brutto, kg)	120,500

Gewicht PAP (kg)	7,500
Gewicht PVC (kg)	0,000
Länge (verpackt, mm)	800
Breite (verpackt, mm)	600
Höhe (verpackt, mm)	1360

Stückliste.



01010004
Steckschlüsseleinsatz



01010005
Steckschlüsseleinsatz



01010006
Steckschlüsseleinsatz



01010007
Steckschlüsseleinsatz



01010008
Steckschlüsseleinsatz



01010009
Steckschlüsseleinsatz



01010010
Steckschlüsseleinsatz



01010011
Steckschlüsseleinsatz



01010012
Steckschlüsseleinsatz



01010013
Steckschlüsseleinsatz



01010014
Steckschlüsseleinsatz



01010045
Steckschlüsseleinsatz



01010055
Steckschlüsseleinsatz



01020004
Steckschlüsseleinsatz



01020005
Steckschlüsseleinsatz



01020006
Steckschlüsseleinsatz



01020007
Steckschlüsseleinsatz



01020008
Steckschlüsseleinsatz



01020009
Steckschlüsseleinsatz



01020010
Steckschlüsseleinsatz



01020011
Steckschlüsseinsatz



01020012
Steckschlüsseinsatz



01020013
Steckschlüsseinsatz



01020045
Steckschlüsseinsatz



01020055
Steckschlüsseinsatz



01050003
INHEX-
Schraubendrehereinsatz
z



01050004
INHEX-
Schraubendrehereinsatz
z



01050005
INHEX-
Schraubendrehereinsatz
z



01050006
INHEX-
Schraubendrehereinsatz
z



01050025
INHEX-
Schraubendrehereinsatz
z



01140006
Gelenk-
Steckschlüsseinsatz



01140008
Gelenk-
Steckschlüsseinsatz



01140010
Gelenk-
Steckschlüsseinsatz



01270004
Steckschlüsseinsatz



01270005
Steckschlüsseinsatz



01270006
Steckschlüsseinsatz



01270007
Steckschlüsseinsatz



01270008
Steckschlüsseinsatz



01270010
Steckschlüsseinsatz



01290001
Schraubendrehereinsatz
z



01290002
Schraubendrehereinsatz
z



01300001
Schraubendrehereinsatz
z



01300002
Schraubendrehereinsatz
z



01351008
Schraubendrehereinsatz
z



01351009
Schraubendrehereinsatz
z



01351010
Schraubendrehereinsatz
z



01351015
Schraubendrehereinsatz
z



01351020
Schraubendrehereinsatz
z



01351025
Schraubendrehereinsatz
z



01351027
Schraubendrehereinsatz
z



01351030
Schraubendrehereinsatz
z



02010010
Steckschlüsseinsatz



02010011
Steckschlüsseinsatz



02010012
Steckschlüsseinsatz



02010013
Steckschlüsseinsatz



02010014
Steckschlüsseinsatz



02010015
Steckschlüsseinsatz



02010016
Steckschlüsseinsatz



02010017
Steckschlüsseinsatz



02010018
Steckschlüsseinsatz



02010019
Steckschlüsseinsatz



02010020
Steckschlüsseinsatz



02010021
Steckschlüsseinsatz



02010022
Steckschlüsseinsatz



02020010
Steckschlüsseinsatz



02020011
Steckschlüsseinsatz



02020012
Steckschlüsseinsatz



02020013
Steckschlüsseinsatz



02020014
Steckschlüsseinsatz



02020015
Steckschlüsseinsatz



02020016
Steckschlüsseinsatz



02020017
Steckschlüsseinsatz



02020018
Steckschlüsseinsatz



02020019
Steckschlüsseinsatz



02020021
Steckschlüsseinsatz



02020022
Steckschlüsseinsatz



02050006
INHEX-
Schraubendrehereinsatz
z



02050007
INHEX-
Schraubendrehereinsatz
z



02050008
INHEX-
Schraubendrehereinsatz
z



02050010
INHEX-
Schraubendrehereinsatz
z



02060005
Schraubendrehereinsatz
z



02060006
Schraubendrehereinsatz
z



02060008
Schraubendrehereinsatz
z



02060010
Schraubendrehereinsatz
z



02100025
Schraubendrehereinsatz
z



02100027
Schraubendrehereinsatz
z



02100030
Schraubendrehereinsatz
z



02100040
Schraubendrehereinsatz
z



02100045
Schraubendrehereinsatz
z



02110010
Steckschlüsseleinsatz



02110011
Steckschlüsseleinsatz



02110012
Steckschlüsseleinsatz



02110013
Steckschlüsseleinsatz



02110014
Steckschlüsseleinsatz



02110015
Steckschlüsseleinsatz



02110016
Steckschlüsseleinsatz



02110017
Steckschlüsseleinsatz



02110018
Steckschlüsseleinsatz



02110019
Steckschlüsseleinsatz



02110020
Steckschlüsseleinsatz



02110021
Steckschlüsseleinsatz



02110022
Steckschlüsseleinsatz



02120036
Zündkerzen-
Steckschlüsseleinsatz



02130018
Zündkerzen-
Steckschlüsseleinsatz



02151007
INHEX-
Schraubendrehereinsatz
z

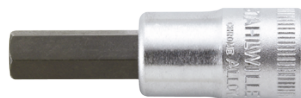

02151009
INHEX-
Schraubendrehereinsatz
z



02270008
Steckschlüsseleinsatz



02270010
Steckschlüsseleinsatz



02270012
Steckschlüsseleinsatz



02270014
Steckschlüsseleinsatz



03030010
Steckschlüsseleinsatz



03030011
Steckschlüsseleinsatz



03030012
Steckschlüsseinsatz



03030013
Steckschlüsseinsatz



03030014
Steckschlüsseinsatz



03030015
Steckschlüsseinsatz



03030016
Steckschlüsseinsatz



03030017
Steckschlüsseinsatz



03030018
Steckschlüsseinsatz



03030019
Steckschlüsseinsatz



03030020
Steckschlüsseinsatz



03030021
Steckschlüsseinsatz



03030022
Steckschlüsseinsatz



03030023
Steckschlüsseinsatz



03030024
Steckschlüsseinsatz



03030026
Steckschlüsseinsatz



03030027
Steckschlüsseinsatz



03030028
Steckschlüsseinsatz



03030030
Steckschlüsseinsatz



03030032
Steckschlüsseinsatz



03050006
INHEX-
Schraubendrehereinsatz
z

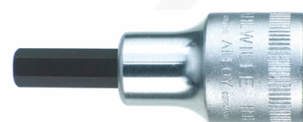

03050007
INHEX-
Schraubendrehereinsatz
z



03050008
INHEX-
Schraubendrehereinsatz
z



03050010
INHEX-
Schraubendrehereinsatz
z



03050012
INHEX-
Schraubendrehereinsatz
z



03050014
INHEX-
Schraubendrehereinsatz
z



03050017
INHEX-
Schraubendrehereinsatz
z



03060005
Schraubendrehereinsatz
z



03060006
Schraubendrehereinsatz
z

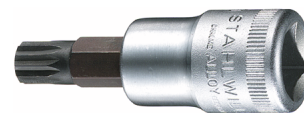

03060008
Schraubendrehereinsatz
z



03060010
Schraubendrehereinsatz
z



03060012
Schraubendrehereinsatz
z



03060014
Schraubendrehereinsatz
z

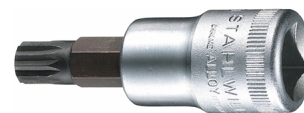

03060016
Schraubendrehereinsatz
z

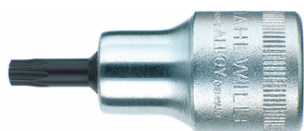

03100027
Schraubendrehereinsatz
z



03100030
Schraubendrehereinsatz
z



03100040
Schraubendrehereinsatz
z



03100045
Schraubendrehereinsatz
z



03100050
Schraubendrehereinsatz
z



03100055
Schraubendrehereinsatz
z



03100060
Schraubendrehereinsatz
z



03100070
Schraubendrehereinsatz
z



03270012
Steckschlüsseleinsatz



03270014
Steckschlüsseleinsatz



03270016
Steckschlüsseleinsatz



03270018
Steckschlüsseleinsatz



03270020
Steckschlüsseinsatz



03270024
Steckschlüsseinsatz



11010020
Wobble-Drive-
Verlängerung



11011502
QR-
Steckschlüsselverlänge-
rung



11011504
QR-
Steckschlüsselverlänge-
rung



11011506
QR-
Steckschlüsselverlänge-
rung



11021500
QuickRelease-
Kardangeln



11030002
Vergrößerungsstück



11040000
Flexible Verlängerung



11111020
QR-Feinzahnknarre



11180010
Bit-Halter



11261010
QR-
Feinzahngelenkknarre



12010007
Wobble-Drive-
Steckschlüsselverlänge-
rung



12011503
QR-
Steckschlüsselverlänge-
rung



12011506
QR-
Steckschlüsselverlänge-
rung



12011510
QR-
Steckschlüsselverlänge-
rung



12021500
QuickRelease-
Kardangeln



12030001
Reduzierstück



12030003
Vergrößerungsstück



12111020
QR-Feinzahnknarre



13010005
Wobble-Drive-
Steckschlüsselverlänge-
rung



13011505
QR-
Steckschlüsselverlänge-
rung



13011510
QR-
Steckschlüsselverlänge-
rung



13021000
QR-Kardangelenke



13030002
Reduzierstück



13061015
Gelenkgriff



13111120
QR-Feinzahnknarre



13160000
Teleskopknarre



18120001
Bit-
Ratschenschraubendre-
her



18120002
Bit-
Ratschenschraubendre-
her



23031017
IMPACT-Radmuttern-
Steckschlüsseleinsatz



23031019
IMPACT-Radmuttern-
Steckschlüsseleinsatz



23031021
IMPACT-Radmuttern-
Steckschlüsseleinsatz



40080606
Ringmaulschlüssel



40080707
Ringmaulschlüssel



40080808
Ringmaulschlüssel



40080909
Ringmaulschlüssel



40081010
Ringmaulschlüssel



40081111
Ringmaulschlüssel



40081212
Ringmaulschlüssel



40081313
Ringmaulschlüssel



40081414
Ringmaulschlüssel



40081515
Ringmaulschlüssel



40081616
Ringmaulschlüssel



40081717
Ringmaulschlüssel



40081818
Ringmaulschlüssel



40081919
Ringmaulschlüssel



40082121
Ringmaulschlüssel



40082222
Ringmaulschlüssel



40082424
Ringmaulschlüssel



40082727
Ringmaulschlüssel



40083030
Ringmaulschlüssel



40083232
Ringmaulschlüssel



41080810
Doppelringschlüssel
offen abgew.



41081113
Doppelringschlüssel
offen abgew.



41081214
Doppelringschlüssel
offen abgew.



41170808
Ratschenringmaulschlüssel



41170909
Ratschenringmaulschlüssel



41171010
Ratschenringmaulschlüssel



41171111
Ratschenringmaulschlüssel



41171212
Ratschenringmaulschlüssel



41171313
Ratschenringmaulschlüssel



41171414
Ratschenringmaulschlüssel



41171515
Ratschenringmaulschlüssel



41171616
Ratschenringmaulschlüssel



41171717
Ratschenringmaulschlüssel



41171818
Ratschenringmaulschlüssel



41171919
Ratschenringmaulschlüssel



41172121
Ratschenringmaulschlüssel



41172222
Ratschenringmaulschlüssel



41172424
Ratschenringmaulschlüssel



46223500
Schlitzschraubendreher DRALL+



46223520
Schlitzschraubendreher DRALL+



46223555
Schlitzschraubendreher DRALL+



46223565
Schlitzschraubendreher DRALL+



46303001
PH-Kreuzschlitzschraubendreher DRALL+



46323303
PH-Kreuzschlitzschraubendreher DRALL+



46503006
TORX® Schraubendreher DRALL+



46503007
TORX® Schraubendreher DRALL+



46503008
TORX® Schraubendreher DRALL+



46503009
TORX® Schraubendreher DRALL+



46503010
TORX® Schraubendreher DRALL+



46503015
TORX® Schraubendreher DRALL+



46503020
TORX® Schraubendreher DRALL+



46503025
TORX® Schraubendreher DRALL+



46503027
TORX® Schraubendreher DRALL+



46503030
TORX® Schraubendreher DRALL+



47241060
Schlitzschraubendreher DRALL®



47341002
PH-
Kreuzschlitzschrauben
dreher DRALL®



65434102
Sicherungsringzange
f. Innenringe



65444121
Sicherungsringzange
f. Innenringe



65454102
Sicherungsringzange
f. Außenringe



65464121
Sicherungsringzange
f. Außenringe



65632250
Universal-Gripzange



65726240
Wasserpumpenzange



67001180
Kombinationszangen



67211160
Kraft-Seitenschneider



67301200
Telefonzange



67311200
Telefonzange



70020003
Flachmeißel



70020005
Flachmeißel



70050005
Körner achtkantig



70070002
Splinttreiber



70070003
Splinttreiber



70070004
Splinttreiber



70070005
Splinttreiber



70070006
Splinttreiber



70110011
Schlosserhammer



70171035
Nylonhammer



72033101
Dichtungsschaber



72060200
Kunststoffschaber



72060201
Kunststoffschaber



72060202
Kunststoffschaber



72060203
Kunststoffschaber



72060204
Kunststoffschaber



72090002
Hebeleisen



74240001
Präzisions-Fühlerlehre



77020000
Kabelmesser



77260025
Magnetheber

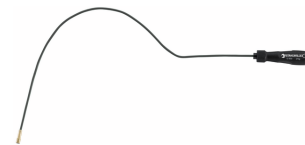

77260027
Magnetheber



77301020
Flaschenöffner

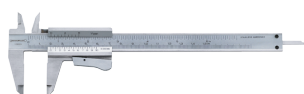

77371001
Messschieber



77371004
Reifenprofil-
Messschieber



77380001
Auto-Prüflampe



77401032
Teleskop-
Edelstahlspiegel



77440001
Bremsattelbürste



77490016
Arbeitsleuchte



96080156
Bit-Box

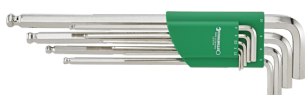

96432600
Kugelkopf-
Winkelschraubendre-
r-Satz

GTIN-Code.



Bilder.

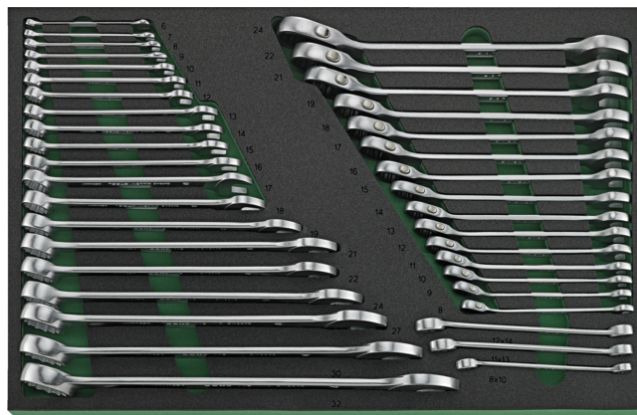
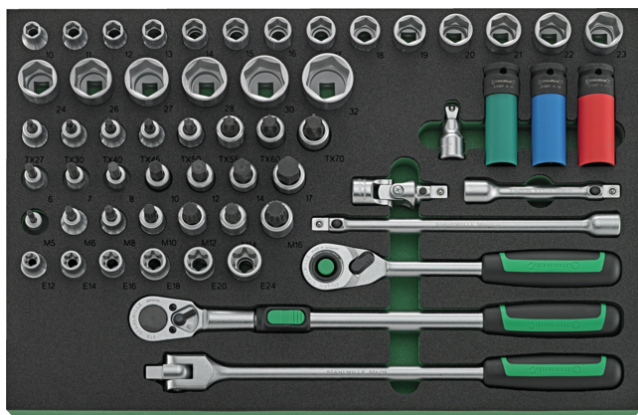
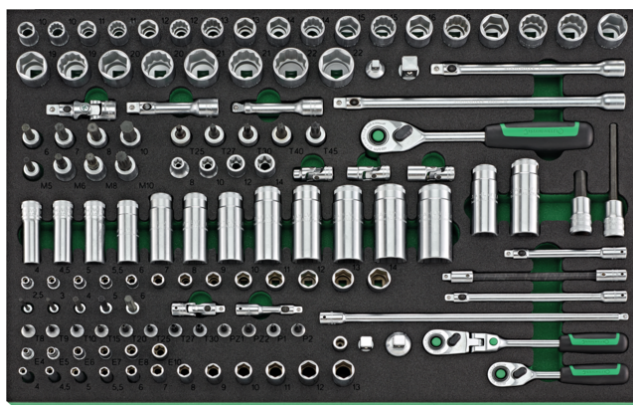



STAHLWILLE Eduard Wille GmbH

Lindenallee 27 · 42349 Wuppertal · Deutschland · Tel.: +49 202 4791-0 · Fax: +49 202 4791-393

info@stahlwille.de · www.stahlwille.com

© STAHLWILLE Eduard Wille GmbH, Wuppertal