

Open-ended striking spanners

4204



Product no. **42040065**
GTIN **4018754023745**
Model **4204 65**

Label. Open-ended striking spanner Size 65mm L.342mm

Properties.

- special steel, steel grey
- DIN 133

Technical drawing.

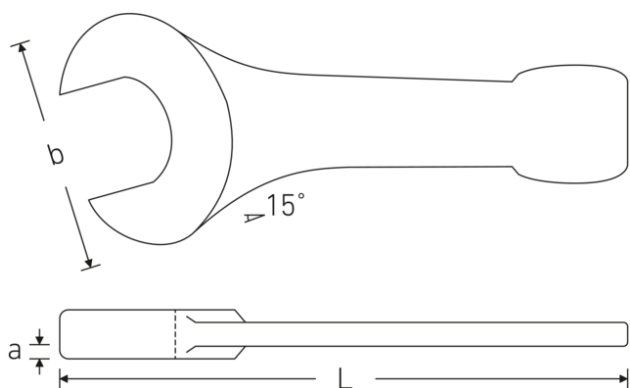

Technical attributes.

Size 1 [mm]	65 mm
Length mm (L)	342 mm
Width mm (b)	138 mm
a	27 mm
DIN	DIN 133
Alloy	Special steel
Surface	steel grey

Logistics data.

Product no.	42040065
GTIN	4018754023745
Weight (g)	3285 g
Volume (packaged, dm ³)	1.39725 dm ³
Packing standard	1
WEEE/ElektroG	nicht ear-pflichtig
Customs tariff no.	82041100

Country of origin AWR	GERMANY
Region of origin	Nordrhein-Westfalen
Depth mm (IFS)	345
Width mm (IFS)	135
Height mm (IFS)	30
Weight (gross, kg)	3,204
Weight PAP (kg)	0,000
Weight PVC (kg)	0,000
Length (packaged, mm)	345
Width (packaged, mm)	135
Height (packaging, mm)	30

GTIN.



STAHLWILLE Eduard Wille GmbH

Lindenallee 27 · 42349 Wuppertal · Germany · Phone: +49 202 4791-0

info@stahlwille.de · www.stahlwille.com

© STAHLWILLE Eduard Wille GmbH, Wuppertal