



Adjustable spanners, imperial

4026



Product no. **40260108**
GTIN **4018754299584**
Model **4026 8**

Label. Adjustable spanner max. size 30mm L.207mm

Properties.

- counter-clockwise adjustment screw
- jaw angled 22.5°
- Chrome Alloy Steel, phosphated
- DIN 3117 / ISO 6787 Form B / ASME B 107.100

Technical drawing.

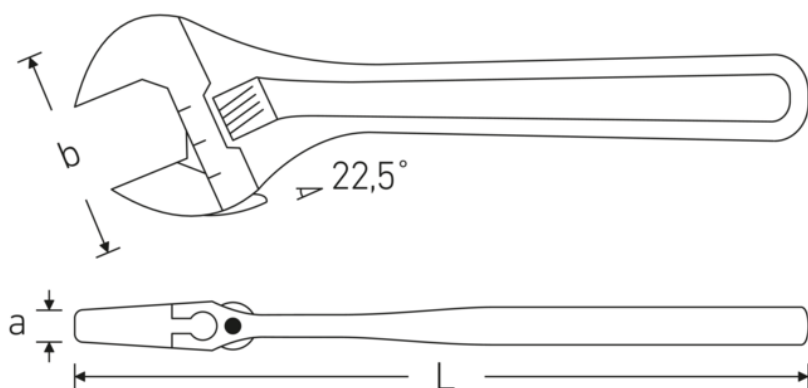

Technical attributes.

Size	8
Max. spanner size	30 mm
Length mm (L)	207 mm
Width mm (b)	62 mm
a	14 mm

Logistics data.

Product no.	40260108
GTIN	4018754299584
Weight (g)	310 g
Volume (packaged, dm ³)	0.71355 dm ³
Packing standard	5

DIN	DIN 3117 / ISO 6787 Form B	WEEE/ElektroG	nicht ear-pflichtig
Alloy	Chrome Vanadium Steel	Customs tariff no.	82041200
Surface	phosphated	Country of origin AWR	SPAIN
		Region of origin	Ausländischer Ursprung
		Depth mm (IFS)	206
		Width mm (IFS)	57
		Height mm (IFS)	13
		Weight (gross, kg)	1,235
		Weight PAP (kg)	0,000
		Weight PVC (kg)	0,010
		Length (packaged, mm)	213
		Width (packaged, mm)	67
		Height (packaging, mm)	50

GTIN.



STAHLWILLE Eduard Wille GmbH

Lindenallee 27 · 42349 Wuppertal · Germany · Phone: +49 202 4791-0

info@stahlwille.de · www.stahlwille.com

© STAHLWILLE Eduard Wille GmbH, Wuppertal