



IMPACT sockets 3/4"

55IMP

Product no. 25010034
GTIN 4018754015757
Model 55 IMP 34



Label. IMPACT socket 3/4 " 34mm L.54mm

- Properties.**
- with hex
 - 3/4" internal square drive
 - Chrome Alloy Steel, gunmetal finish
 - DIN 3129 / ISO 1711-2

Product highlights.



Optimised functionality.

All IMPACT sockets have a through cross hole for the connecting pin and a deep groove for the rubber locking ring. The locking pin is not stressed during use.

High fitting accuracy.

The high fitting accuracy due to tight tolerances guarantees optimum, backlash-free transmission of forces to the socket.



PRODUCT IMAGE
IN PROGRESS

Technical drawing.

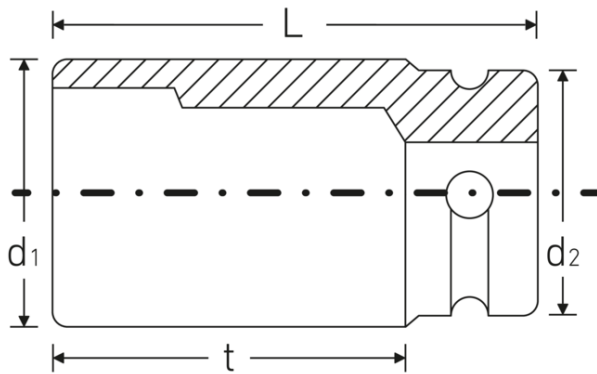

Technical attributes.

Size [mm]	34 mm
Square drive inner (inch)	3/4 "
Length mm (L)	54 mm
Drive profile	hex
d1	52,4 mm
d2	44 mm
DIN	DIN 3129 / ISO 1711-2
Alloy	Chrome Alloy Steel, gunmetal finish
t	29 mm

Logistics data.

Product no.	25010034
GTIN	4018754015757
Weight (g)	490 g
Volume (packaged, dm3)	0.306075 dm3
Packing standard	2
WEEE/ElektroG	nicht ear-pflichtig
Customs tariff no.	82042000
Country of origin AWR	GERMANY
Region of origin	Nordrhein-Westfalen
Depth mm (IFS)	54
Width mm (IFS)	52
Height mm (IFS)	52
Weight (gross, kg)	0,980
Weight PAP (kg)	0,000
Weight PVC (kg)	0,007
Length (packaged, mm)	105
Width (packaged, mm)	53
Height (packaging, mm)	55

GTIN.



Accessories (for).



39023540
IMPACT locking pin



39013650
IMPACT rubber ring