

Adjustable spanners, imperial

4025



Product no. **40250104**
GTIN **4018754299492**
Model **4025 4**

Label. Adjustable spanner max. size 13mm L.115mm

- Properties.**
- clockwise adjustment screw
 - jaw angled 22.5°
 - Chrome Alloy Steel, chrome-plated
 - DIN 3117 / ISO 6787 Form B / ASME B107.100



Technical drawing.

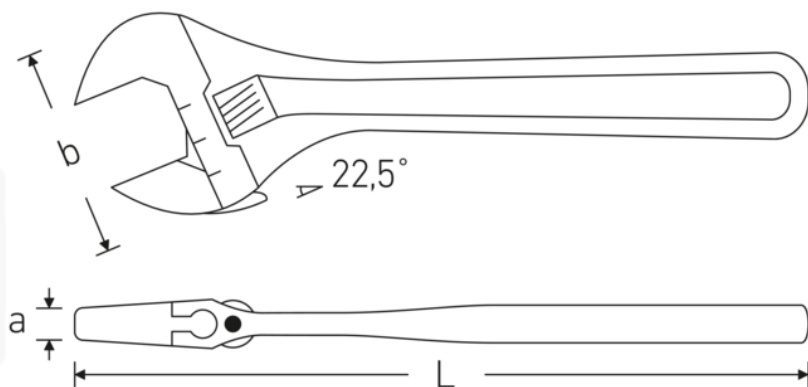

Technical attributes.

Size	4
Max. spanner size	13 mm
Length mm (L)	115 mm
Width mm (b)	35 mm
a	9,5 mm
DIN	DIN 3117 / ISO 6787 Form B
Alloy	Chrome Vanadium Steel
Surface	chrome-plated

Logistics data.

Product no.	40250104
GTIN	4018754299492
Weight (g)	52 g
Volume (packaged, dm3)	0.173394 dm3
Packing standard	5
WEEE/ElektroG	nicht ear-pflichtig
Customs tariff no.	82041200
Country of origin AWR	SPAIN
Region of origin	Ausländischer Ursprung
Depth mm (IFS)	115
Width mm (IFS)	32
Height mm (IFS)	9
Weight (gross, kg)	0,275
Weight PAP (kg)	0,000
Weight PVC (kg)	0,007
Length (packaged, mm)	117
Width (packaged, mm)	38
Height (packaging, mm)	39

GTIN.



STAHLWILLE Eduard Wille GmbH

Lindenallee 27 · 42349 Wuppertal · Germany · Phone: +49 202 4791-0

info@stahlwille.de · www.stahlwille.com

© STAHLWILLE Eduard Wille GmbH, Wuppertal