

## Adjustable spanners, imperial

**4025**



Product no. **40250115**  
GTIN **4018754299546**  
Model **4025 15**

**Label.** Adjustable spanner max. size 44mm L.386mm

- Properties.**
- clockwise adjustment screw
  - jaw angled 22.5°
  - Chrome Alloy Steel, chrome-plated
  - DIN 3117 / ISO 6787 Form B / ASME B107.100



## Technical drawing.

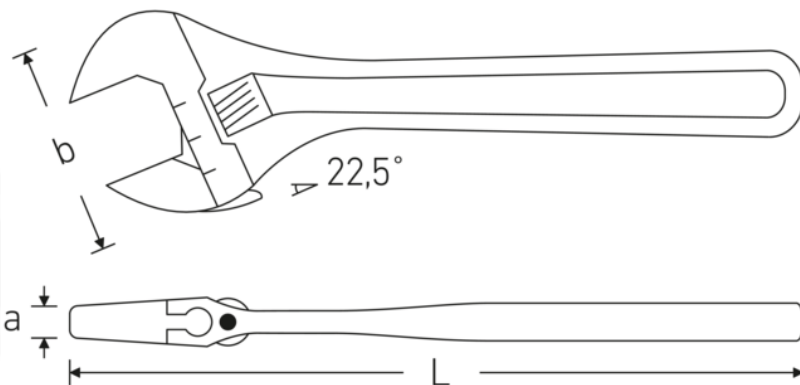

## Technical attributes.

Size	15
Max. spanner size	44 mm
Length mm (L)	386 mm
Width mm (b)	106 mm
a	25 mm
DIN	DIN 3117 / ISO 6787 Form B
Alloy	Chrome Vanadium Steel
Surface	chrome-plated

## Logistics data.

Product no.	40250115
GTIN	4018754299546
Weight (g)	1320 g
Volume (packaged, dm3)	0.97465 dm3
Packing standard	1
WEEE/ElektroG	nicht ear-pflichtig
Customs tariff no.	82041200
Country of origin AWR	SPAIN
Region of origin	Ausländischer Ursprung
Depth mm (IFS)	385
Width mm (IFS)	100
Height mm (IFS)	24
Weight (gross, kg)	1,287
Weight PAP (kg)	0,000
Weight PVC (kg)	0,018
Length (packaged, mm)	386
Width (packaged, mm)	101
Height (packaging, mm)	25

## GTIN.



**STAHLWILLE Eduard Wille GmbH**

Lindenallee 27 · 42349 Wuppertal · Germany · Phone: +49 202 4791-0

info@stahlwille.de · www.stahlwille.com

© STAHLWILLE Eduard Wille GmbH, Wuppertal