



## IMPACT sockets 3/4"

### 55IMP

Product no.	25010041
GTIN	4018754233885
Model	55 IMP 41



**Label.** IMPACT socket 3/4 " 41mm L.58mm

- Properties.**
- with hex
  - 3/4" internal square drive
  - Chrome Alloy Steel, gunmetal finish
  - DIN 3129 / ISO 1711-2

## Product highlights.



### Optimised functionality.

All IMPACT sockets have a through cross hole for the connecting pin and a deep groove for the rubber locking ring. The locking pin is not stressed during use.

### High fitting accuracy.

The high fitting accuracy due to tight tolerances guarantees optimum, backlash-free transmission of forces to the socket.



PRODUCT IMAGE  
IN PROGRESS

## Technical drawing.

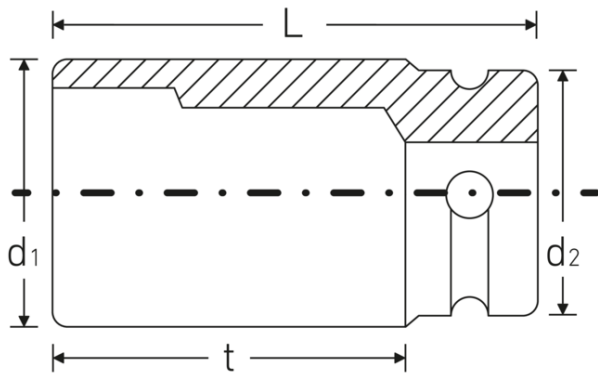

## Technical attributes.

Size [mm]	41 mm
Square drive inner (inch)	3/4 "
Length mm (L)	58 mm
Drive profile	hex
d1	60 mm
d2	44 mm
DIN	DIN 3129 / ISO 1711-2
Alloy	Chrome Alloy Steel, gunmetal finish
t	34,5 mm

## Logistics data.

Product no.	25010041
GTIN	4018754233885
Weight (g)	500 g
Volume (packaged, dm3)	0.198476 dm3
Packing standard	1
WEEE/ElektroG	nicht ear-pflichtig
Customs tariff no.	82042000
Country of origin AWR	TAIWAN
Region of origin	Ausländischer Ursprung
Depth mm (IFS)	58
Width mm (IFS)	57
Height mm (IFS)	57
Weight (gross, kg)	0,500
Weight PAP (kg)	0,000
Weight PVC (kg)	0,008
Length (packaged, mm)	59
Width (packaged, mm)	58
Height (packaging, mm)	58

## GTIN.



## Accessories (for).



39023540  
IMPACT locking pin



39013650  
IMPACT rubber ring