



Adjustable spanners, imperial

4026



Product no. **40260112**
GTIN **4018754299607**
Model **4026 12**

Label. Adjustable spanner max. size 39mm L.311mm

- Properties.**
- counter-clockwise adjustment screw
 - jaw angled 22.5°
 - Chrome Alloy Steel, phosphated
 - DIN 3117 / ISO 6787 Form B / ASME B 107.100

Technical drawing.

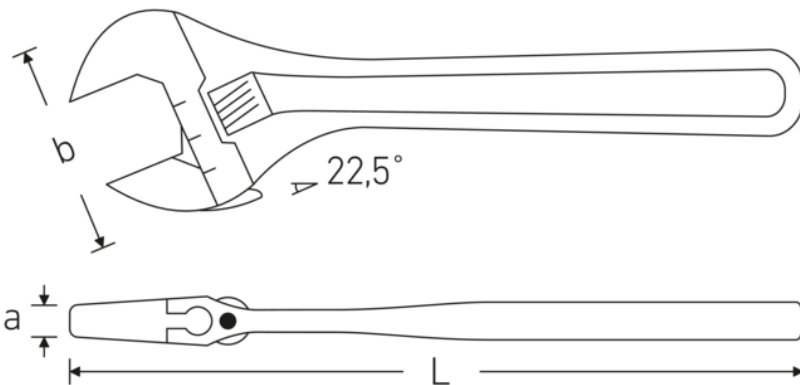

Technical attributes.

Size	12
Max. spanner size	39 mm
Length mm (L)	311 mm
Width mm (b)	84 mm
a	19 mm

Logistics data.

Product no.	40260112
GTIN	4018754299607
Weight (g)	805 g
Volume (packaged, dm ³)	1.85328 dm ³
Packing standard	5

DIN	DIN 3117 / ISO 6787 Form B	WEEE/ElektroG	nicht ear-pflichtig
Alloy	Chrome Vanadium Steel	Customs tariff no.	82041200
Surface	phosphated	Country of origin AWR	SPAIN
		Region of origin	Ausländischer Ursprung
		Depth mm (IFS)	310
		Width mm (IFS)	80
		Height mm (IFS)	18
		Weight (gross, kg)	3,495
		Weight PAP (kg)	0,000
		Weight PVC (kg)	0,016
		Length (packaged, mm)	312
		Width (packaged, mm)	110
		Height (packaging, mm)	54

GTIN.



STAHLWILLE Eduard Wille GmbH

Lindenallee 27 · 42349 Wuppertal · Germany · Phone: +49 202 4791-0

info@stahlwille.de · www.stahlwille.com

© STAHLWILLE Eduard Wille GmbH, Wuppertal