

Adjustable spanners, imperial

4025



Product no. **40250108**
GTIN **4018754299515**
Model **4025 8**

Label. Adjustable spanner max. size 30mm L.207mm

- Properties.**
- clockwise adjustment screw
 - jaw angled 22.5°
 - Chrome Alloy Steel, chrome-plated
 - DIN 3117 / ISO 6787 Form B / ASME B107.100



Technical drawing.

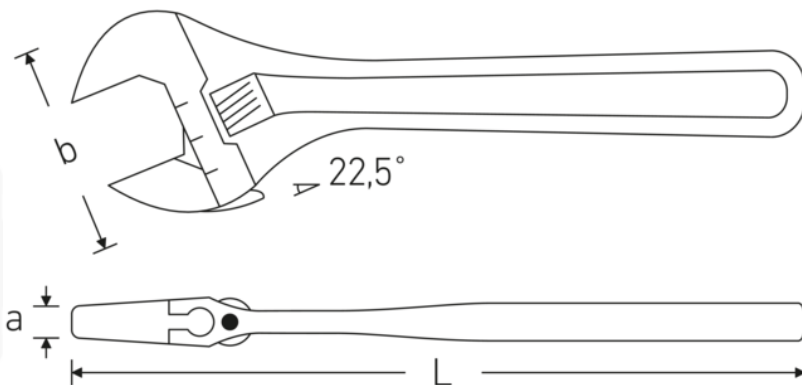

Technical attributes.

Size	8
Max. spanner size	30 mm
Length mm (L)	207 mm
Width mm (b)	62 mm
a	14 mm
DIN	DIN 3117 / ISO 6787 Form B
Alloy	Chrome Vanadium Steel
Surface	chrome-plated

Logistics data.

Product no.	40250108
GTIN	4018754299515
Weight (g)	310 g
Volume (packaged, dm3)	0.756 dm3
Packing standard	5
WEEE/ElektroG	nicht ear-pflichtig
Customs tariff no.	82041200
Country of origin AWR	SPAIN
Region of origin	Ausländischer Ursprung
Depth mm (IFS)	205
Width mm (IFS)	58
Height mm (IFS)	13
Weight (gross, kg)	1,330
Weight PAP (kg)	0,000
Weight PVC (kg)	0,010
Length (packaged, mm)	210
Width (packaged, mm)	60
Height (packaging, mm)	60

GTIN.



STAHLWILLE Eduard Wille GmbH

Lindenallee 27 · 42349 Wuppertal · Germany · Phone: +49 202 4791-0

info@stahlwille.de · www.stahlwille.com

© STAHLWILLE Eduard Wille GmbH, Wuppertal