



## Tool trolleys 98 PRO

### 98/7 PRO

Product no.	81200171
GTIN	4018754334513
Model	TTS 98/7 R PRO



#### Label.

Tool trolley 98/7 PRO 7 Drawer 651 x 1001 x 1020 mm red, RAL 3020; black, RAL 9005

#### Properties.

- three-stage safety concept:
  - central locking with a lateral cylinder lock and hinged key
  - individual locks prevent inadvertent opening during transit
  - tilt protection - multiple drawers cannot be pulled out at the same time
- 100 % larger drawer volume compared to the 93 and TTS 95 PRO
- stainless steel with reinforced handle
- all-round collision protection with impact damping
- tightly welded, resilient work and storage surface; end panel made of stainless steel
- oil and acid-resistant, ball-guided, smooth-running wheels (Ø 125 mm) with thread guards to protect the bearings from dirt and threads, with 2 locking brakes
- paper roller and spray can holder included
- 7 easy-to-remove drawers, black, with full-extension runners and bearing cage guide
- two-sided perforated panel for hooks no. 8031-8041, e.g. for larger tools
- can be fitted with STAHLWILLE standard and TCS inlays

## Benefits.

Maximum storage area thanks to width of 100 cm, 65 cm deep and drawer full extension.

7 easily removable drawers.

High static load-bearing capacity up to 1,400 kg.

High quality, durable materials such as tightly welded stainless steel top tray.

Oil and acid-resistant smooth-running castors (Ø 125 mm) with thread protection and 2 locking brakes.



## Product highlights.



### Simply more space.

With a width of more than 100 cm, a depth of 65 cm and a drawer full extension, our biggest tool trolley provides maximum storage space and room for your tools. In comparison to the 93 and 95 PRO models, the TTS 98 PRO provides 100 % more drawer volume with premium quality.



### Takes on anything.

High-quality materials such as the tightly welded stainless steel tray provide the durability that is typical of STAHLWILLE, and prevent liquids from penetrating the interior of the trolley. The working area of 740 x 570 mm is particularly suitable for working on large components. Thanks to its robust design, the 98 PRO achieves a static load-bearing capacity of 1,400 kg. The drawers can be loaded with up to 40 kg thanks to stiffening, and the bottom drawer can even be loaded with up to 60 kg.



### Secure down to the last detail.

The drawers are centrally locked using a cylinder lock with a folding key. The single-drawer lock prevents unintentional opening while driving. In addition, only one drawer can always be opened at a time, ensuring reliable tipping protection.



### Everything in its place.

The TTS 98 PRO can be supplemented with the STAHLWILLE Tool Control System. The TCS inlays protect the tools and keep things in order. The signal colour makes it immediately clear, if a tool is missing. The 3D cutouts make quick and convenient removal possible.



### Full configuration as standard.

Whether paper roll and spray can holders, all-round impact protection with shock absorption, perforations on both sides for attaching accessories, locking brakes or oil and acid-resistant smooth-running castors (Ø 125 mm) with thread protection. Our tool trolley comes with many features as standard.

## Technologies and features.

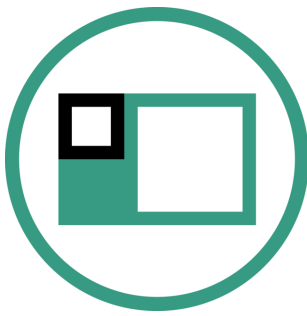

### Modular Inlay System

This flexible solution for tool storage makes it possible to customise your tool trolleys and workbenches with 1/6, 1/3, 2/3 or 3/3 foam inlays.

## Technical drawing.

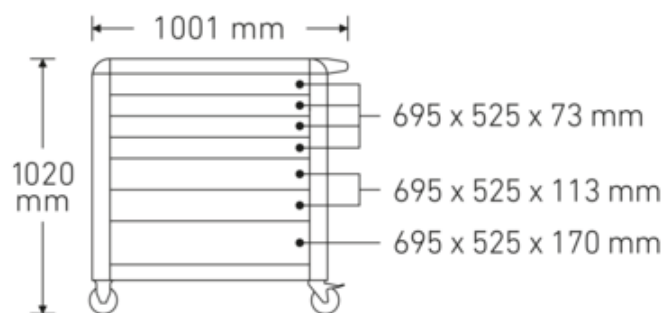
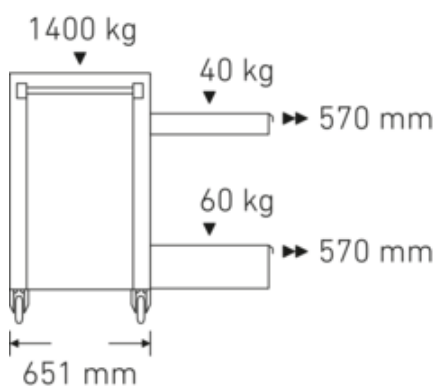

## Technical attributes.

Model No.	98/7 R PRO
Length mm (L)	651 mm
Width mm (b)	1001 mm
Height mm (h)	1020 mm
Number of drawers	7
Load capacity	1400 kg
Internal drawer dimensions mm	695 x 525 x 73 mm (4x) 695 x 525 x 113 mm (2x) 695 x 525 x 170 mm (1x)
Drawer load capacity	40 kg 40 kg 60 kg
Colour	red, RAL 3020; black, RAL 9005
Colour abbreviation	RAL 3020; RAL 9005

## Logistics data.

Product no.	81200171
GTIN	4018754334513
Weight (g)	114000 g
Volume (packaged, dm <sup>3</sup> )	680.166375 dm <sup>3</sup>
Packing standard	1
WEEE/ElektroG	nicht ear-pflichtig
Customs tariff no.	94032080
Region of origin	Ausländischer Ursprung
Depth mm (IFS)	890
Width mm (IFS)	650
Height mm (IFS)	865
Weight (gross, kg)	123,500
Weight PAP (kg)	9,500
Weight PVC (kg)	0,000
Length (packaged, mm)	987
Width (packaged, mm)	745
Height (packaging, mm)	925

## GTIN.



## Accessories (for).



80310090  
Single hook



90432727  
Spray can holder



80320060  
Twin hook

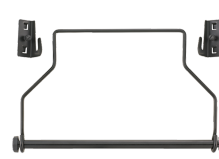

81483004  
Paper roll holder



80340040  
Twin hook



89010040  
Cable holder



80340050  
Twin hook



83812070  
Empty tray for small  
components



80350017  
Rectangular lug



80350020  
Rectangular lug

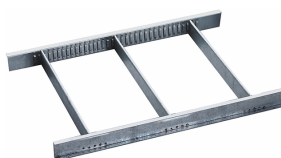

81484001  
Drawer divider



80360012  
Spring clip

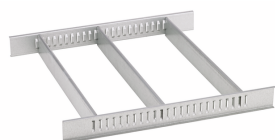

81484002  
Drawer divider



80360018  
Spring clip



81485006  
Spring clip



80360024  
Spring clip



81485012  
Spring clip



80380030  
Container



80310030  
Single hook



80310060  
Single hook



80320030  
Twin hook



89011053  
Waste bin



89010042  
Laptop holder adaptor

## Spare part(s), spare part(s) for.



90432718  
Lock, mechanical

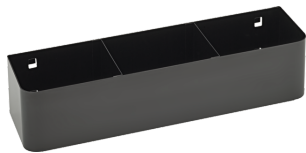

90432719  
Spray can holder



89480003  
Wheel set

81490005  
Wheel set



81490005  
Wheel set

## Images.





**STAHLWILLE Eduard Wille GmbH**

Lindenallee 27 · 42349 Wuppertal · Germany · Phone: +49 202 4791-0

[info@stahlwille.de](mailto:info@stahlwille.de) · [www.stahlwille.com](http://www.stahlwille.com)

© STAHLWILLE Eduard Wille GmbH, Wuppertal