

Adjustable spanners, imperial

4025



Product no. **40250110**
GTIN **4018754299522**
Model **4025 10**

Label. Adjustable spanner max. size 34mm L.259mm

- Properties.**
- clockwise adjustment screw
 - jaw angled 22.5°
 - Chrome Alloy Steel, chrome-plated
 - DIN 3117 / ISO 6787 Form B / ASME B107.100



Technical drawing.

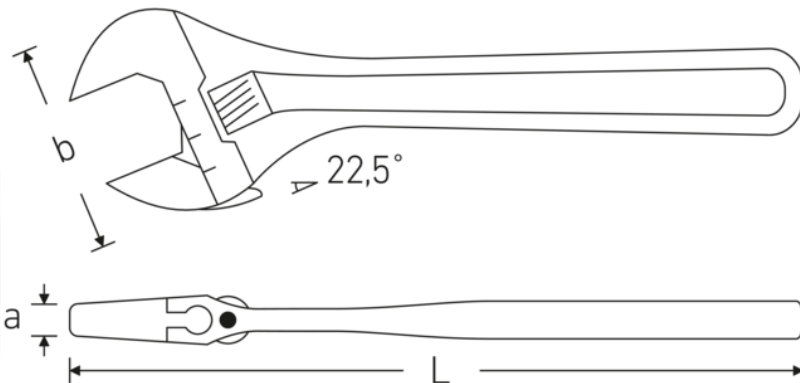

Technical attributes.

Size	10
Max. spanner size	34 mm
Length mm (L)	259 mm
Width mm (b)	74 mm
a	15,8 mm
DIN	DIN 3117 / ISO 6787 Form B
Alloy	Chrome Vanadium Steel
Surface	chrome-plated

Logistics data.

Product no.	40250110
GTIN	4018754299522
Weight (g)	490 g
Volume (packaged, dm3)	1.5568 dm3
Packing standard	5
WEEE/ElektroG	nicht ear-pflichtig
Customs tariff no.	82041200
Country of origin AWR	SPAIN
Region of origin	Ausländischer Ursprung
Depth mm (IFS)	256
Width mm (IFS)	70
Height mm (IFS)	16
Weight (gross, kg)	2,100
Weight PAP (kg)	0,000
Weight PVC (kg)	0,013
Length (packaged, mm)	278
Width (packaged, mm)	80
Height (packaging, mm)	70

GTIN.



STAHLWILLE Eduard Wille GmbH

Lindenallee 27 · 42349 Wuppertal · Germany · Phone: +49 202 4791-0

info@stahlwille.de · www.stahlwille.com

© STAHLWILLE Eduard Wille GmbH, Wuppertal