

Adjustable spanners, imperial

4025



Product no. **40250112**
GTIN **4018754299539**
Model **4025 12**

Label. Adjustable spanner max. size 39mm L.311mm

- Properties.**
- clockwise adjustment screw
 - jaw angled 22.5°
 - Chrome Alloy Steel, chrome-plated
 - DIN 3117 / ISO 6787 Form B / ASME B107.100



Technical drawing.

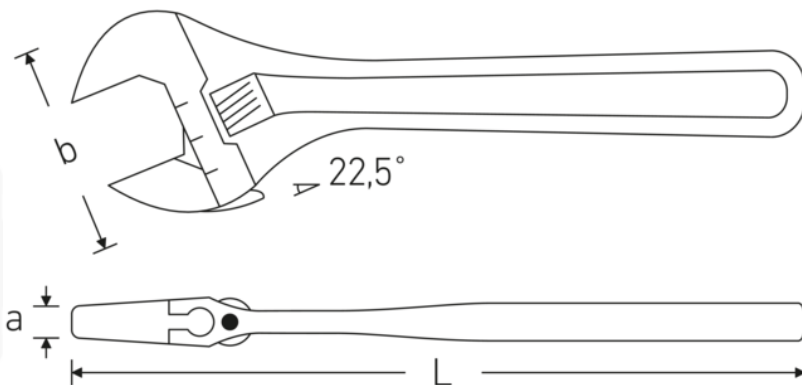

Technical attributes.

Size	12
Max. spanner size	39 mm
Length mm (L)	311 mm
Width mm (b)	84 mm
a	19 mm
DIN	DIN 3117 / ISO 6787 Form B
Alloy	Chrome Vanadium Steel
Surface	chrome-plated

Logistics data.

Product no.	40250112
GTIN	4018754299539
Weight (g)	805 g
Volume (packaged, dm3)	2.024 dm3
Packing standard	5
WEEE/ElektroG	nicht ear-pflichtig
Customs tariff no.	82041200
Country of origin AWR	SPAIN
Region of origin	Ausländischer Ursprung
Depth mm (IFS)	310
Width mm (IFS)	82
Height mm (IFS)	19
Weight (gross, kg)	3,600
Weight PAP (kg)	0,000
Weight PVC (kg)	0,016
Length (packaged, mm)	320
Width (packaged, mm)	115
Height (packaging, mm)	55

GTIN.



STAHLWILLE Eduard Wille GmbH

Lindenallee 27 · 42349 Wuppertal · Germany · Phone: +49 202 4791-0

info@stahlwille.de · www.stahlwille.com

© STAHLWILLE Eduard Wille GmbH, Wuppertal