

Torque wrenches Service MANOSKOP® (N·m/ft·lb)

730 Quick



Product no.	50184565
GTIN	4018754268900
Model	730II/65 QUICK



Label. MANOSKOP® torque wrench 730 Quick 130-650N·m 22 x 28 mm L. 897mm

Properties.

- clicking type with dual stop signal
- no reset to '0' required
- the measuring element is only under load when a force is applied.
- with holder for interchangeable insert tools
- with QuickRelease safety lock
- non-slip adjuster with thumb recess for quick torque adjustment
- fine, tapered pointers
- dual scale N·m/ft·lb
- also available on request as a N·m only version without dual scale
- counter-clockwise tightening by turning the insert tool over
- clicking mechanism insensitive to continuous loads and counter-loads (up to the max. measurement range of the torque wrench)
- optimal calibration with perfectControl® calibration systems No. 7794 or calibration systems No. 7706, 7791
- easy adjustment without disassembly via 2 external adjustment screws
- with 2-component handle
- calibration certificate in accordance with DIN EN ISO 6789-2:2017
- **accuracy ±4 %**

Benefits.

Robust, low-maintenance mechanical torque wrench for controlled screw tightening.

Clicking occurs with a clear haptic and acoustic click signal.

Quick torque setting via the easy-to-operate clamping lever in the handle.

Durable, low-wear flexible rod clicking system eliminates the need to reset to '0'.

Quick adjustment from the outside possible without disassembly.

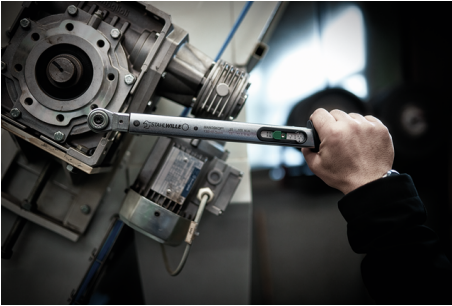
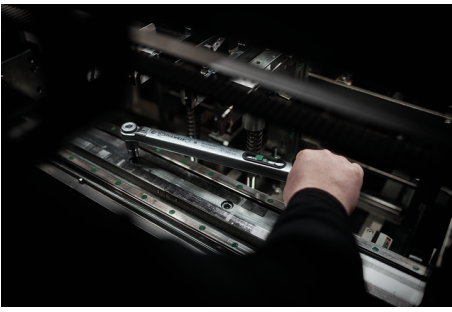

Product highlights.



Rapid adjustment.

Easy and quick adjustment of the torque is carried out by an easy-to-operate clamping lever in the handle. The scale can be moved quickly and safely with an ergonomically shaped, non-slip adjustment element with thumb recess.



PRODUCT IMAGE
IN PROGRESS

Adjustment does not require disassembly.

Quick adjustment from outside, no disassembly of the torque wrench required, with 2 adjustment points for the maximum & minimum values.



PRODUCT IMAGE
IN PROGRESS

Clear fine adjustment.

The user-friendly and easy-to-read dual scale in N·m/ft·lb with main and fine scales allows for precise and easy torque adjustment for reliable and accurate application.

Technologies and features.

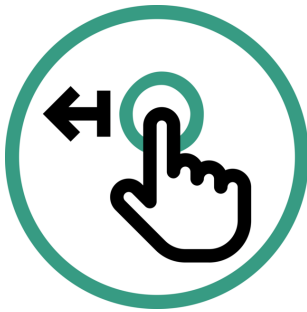

QuickRelease

The QuickRelease safety lock prevents unintentional loss of sockets and insert tools. These click securely into place, and are only released again at the push of a button for a quick tool change. In transducers: The QuickRelease safety lock helps you to quickly mount and change transducers. The transducers lock into the calibration system and only unlock again at the push of the buttons.

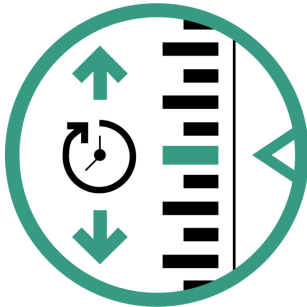

QuickSelect

Lightning-fast target value setting: Unlock the adjustment knob, set the value, and lock the knob again.

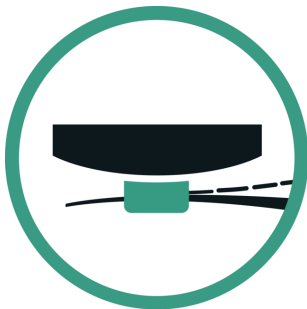

Low-wear bending beam system

Our torque wrench is equipped with a low-wear release system with a bending beam. Unlike conventional torque wrenches with coiled springs, the bending beam is not subjected to any load until the tool is in operation, which means that resetting to '0' is not necessary after use.



2-component handle

Our 2-component handle is non-slip and ergonomically designed. It is resistant to the most common oils, greases, fuels, brake fluids, and Skydrol. The arrow markings on the handle indicate the direction of operation.



DIN EN ISO 6789-2

Our torque wrenches and torque screwdrivers are professionally calibrated in accordance with DIN EN ISO 6789-2 and delivered with a corresponding calibration certificate. We also calibrate angle-controlled torque wrenches in accordance with VDI 2648-2. This ensures the accuracy and traceability of our tools.

Technical drawing.

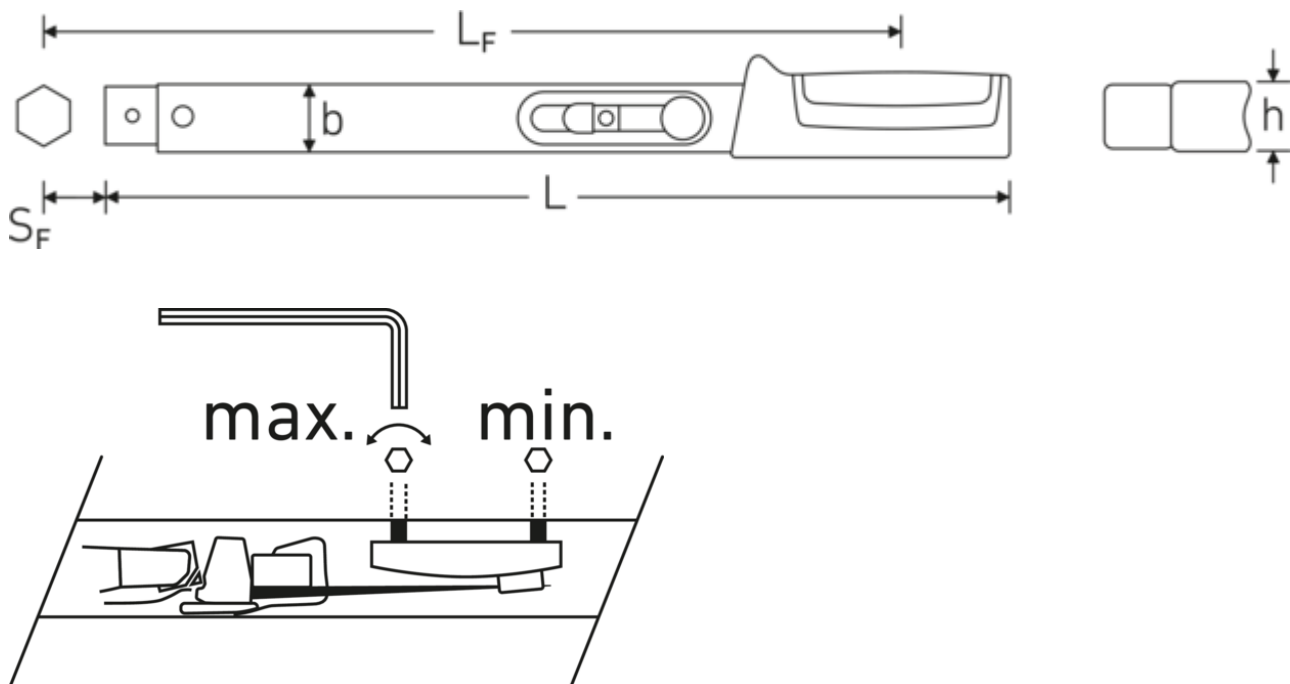

Technical attributes.

Size	II/65
Anzeigeabweichung	±4 %
Tool holder size [internal square]	22 x 28 mm
Measuring range N·m	130-650 N·m
Measuring range ft·lb	100-480 ft·lb
Scale division N·m	20 N·m
Scale division ft·lb	20 ft·lb
Length mm (L)	897 mm
Width mm (b)	30,6 mm
Height mm (h)	25,6 mm
DIN	DIN EN ISO 6789-2:2017
LF	907 mm
SF	55 mm

Logistics data.

Product no.	50184565
GTIN	4018754268900
Weight (g)	4104 g
Volume (packaged, dm ³)	12.48 dm ³
Packing standard	1
WEEE/ElektroG	nicht ear-pflichtig
Customs tariff no.	82041100
Country of origin AWR	GERMANY
Region of origin	Nordrhein-Westfalen
Depth mm (IFS)	1040
Width mm (IFS)	150
Height mm (IFS)	80
Weight (gross, kg)	4,104
Weight PAP (kg)	0,000
Weight PVC (kg)	0,041
Length (packaged, mm)	1040
Width (packaged, mm)	150
Height (packaging, mm)	80

GTIN.



Accessories (for).



81231100
Textile cases for large
torque wrench

Images.

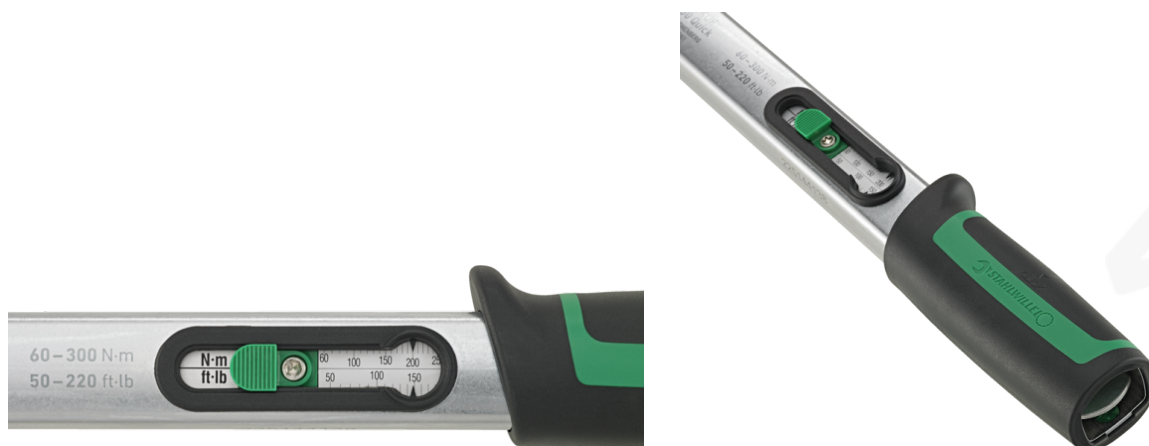

STAHLWILLE Eduard Wille GmbH

Lindenallee 27 · 42349 Wuppertal · Germany · Phone: +49 202 4791-0

info@stahlwille.de · www.stahlwille.com

© STAHLWILLE Eduard Wille GmbH, Wuppertal