



IMPACT sockets 1"

60IMP

Product no. 26010024
GTIN 4018754016242
Model 60 IMP 24



Label. IMPACT socket 1 " 24mm L.58mm

- Properties.**
- with hex
 - 1" internal square drive
 - DIN 3129 / ISO 1711-2
 - Chrome Alloy Steel, gunmetal finish

Product highlights.



Optimised functionality.

All IMPACT sockets have a through cross hole for the connecting pin and a deep groove for the rubber locking ring. The locking pin is not stressed during use.

High fitting accuracy.

The high fitting accuracy due to tight tolerances guarantees optimum, backlash-free transmission of forces to the socket.



PRODUCT IMAGE
IN PROGRESS

Technical drawing.

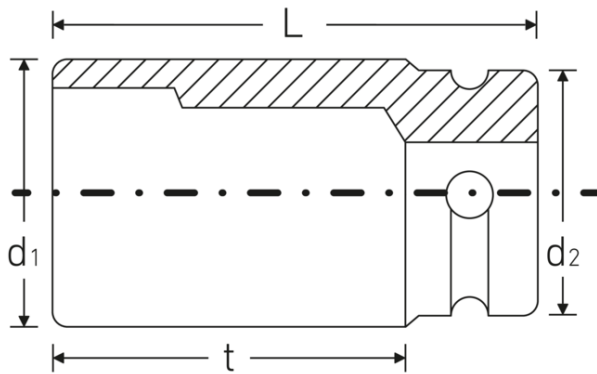

Technical attributes.

Size [mm]	24 mm
Square drive inner (inch)	1 "
Length mm (L)	58 mm
Drive profile	hex
d1	41,5 mm
d2	54 mm
DIN	DIN 3129 / ISO 1711-2
t	28 mm

Logistics data.

Product no.	26010024
GTIN	4018754016242
Weight (g)	638 g
Volume (packaged, dm3)	0.35409 dm3
Packing standard	2
WEEE/ElektroG	nicht ear-pflichtig
Customs tariff no.	82042000
Country of origin AWR	GERMANY
Region of origin	Nordrhein-Westfalen
Depth mm (IFS)	58
Width mm (IFS)	55
Height mm (IFS)	55
Weight (gross, kg)	1,276
Weight PAP (kg)	0,000
Weight PVC (kg)	0,006
Length (packaged, mm)	111
Width (packaged, mm)	55
Height (packaging, mm)	58

GTIN.





STAHLWILLE Eduard Wille GmbH

Lindenallee 27 · 42349 Wuppertal · Germany · Phone: +49 202 4791-0

info@stahlwille.de · www.stahlwille.com

© STAHLWILLE Eduard Wille GmbH, Wuppertal