



Tool set with tool trolley, 349 pieces

95/349QR

Product no. **98830243**
GTIN **4018754363049**
Model **95/349QR**



Label.

Tool set with tool trolley 95/349QR Drawer8 anthracite, RAL 7016 349 pcs.

Properties.

Top features of tool trolley

- three-stage security concept:
 - central locking via side cylinder lock with fold-down key
 - individual locking prevents accidental opening while driving
 - tilt protection – it is not possible to pull out several drawers at the same time.
- black lacquered steel handle with reinforced body connection
- all-round impact protection with shock absorption
- tightly welded, durable work and storage surface
- oil and acid-resistant, ball-bearing smooth-running castors (Ø 125 mm) with thread protection to protect the bearings from dirt and threads, with two locking brakes
- paper roll and spray can holder included
- 8 easily removable drawers (black RAL 9005) with full extension and ball cage guides
- perforation for hooks No. 8031-8041, e.g. for larger tools
- can be equipped with STAHLWILLE standard and TCS inlays
- safely integrated in the modular Tool Control System (TCS) tool insert system.

1 tool trolley **No. 95/8 A PRO**: 8 drawers

Contains 349 pieces:

96830303

13 sockets 1/4" with hex **No. 40**: 4; 4.5; 5; 5.5; 6; 7; 8; 9; 10; 11; 12; 13; 14 mm

12 long sockets, with hex 1/4" **No. 40L**: 4; 4.5; 5; 5.5; 6; 7; 8; 9; 10; 11; 12; 13 mm

6 sockets 1/4" TORX® **No. 40TX**: E4; E5; E6; E7; E8; E10

5 INHEX screwdriver sockets 1/4" **No. 44**: 2.5; 3, 4, 5, 6 mm

2 PHILLIPS® screwdriver sockets 1/4" **No. 44PH**: PH1; PH2

2 PHILLIPS® screwdriver sockets 1/4" **No. 44PZ**: PZ1; PZ2

8 screwdriver sockets TORX® 1/4" **No. 44KTXB**: T8; T9; T10; T15; T20; T25; T27; T30

3 unifix sockets 1/4" **No. 402**: 6; 8, 10 mm

1 Wobble-Drive extension 1/4" **No. 405W**: L. 254 mm

3 QuickRelease extensions 1/4" **No. 408QR**: L. 55; 99; 150 mm

1 QuickRelease universal joint 1/4" **No. 407/1QR**: L. 45 mm

1 flexible extension 1/4" **No. 406**: L. 152 mm

1 bit holder 1/4" **No. 412**: L. 25 mm

1 QuickRelease fine-tooth ratchet 1/4" **No. 415QR N**: L. 117 mm
 1 QuickRelease fine-tooth articulated ratchet 1/4" **No. 416QR**: L. 170 mm
 4 TORX® sockets 3/8" **No. 45TX**: E8; E10; E12; E14
 12 long sockets with bi-hex 3/8" **No. 46**: 10; 11; 12; 13; 14; 15; 16; 17; 18; 19; 21; 22 mm
 4 screwdriver sockets 3/8" for INHEX screws **No. 49**: 6; 7; 8; 10 mm
 4 screwdriver sockets XZN® 3/8" **No. 49X**: M5; M6; M8; M10
 5 TORX® screwdriver sockets 3/8" **No. 49TX**: T25; T27; T30; T40; T45
 13 sockets with bi-hex 3/8" **No. 456**: 10; 11; 12; 13; 14; 15; 16; 17; 18; 19; 20; 21; 22 mm
 1 long socket with bi-hex and rubber insert 3/8" **No. 4600**: 16 mm-5/8"
 1 long spark plug socket insert, with hex and rubber insert 3/8" **No. 4606**: 18 mm/11/16"
 2 screwdriver sockets INHEX 3/8" **No. 1049**: 7; 9 mm
 1 3/8" square drive adaptor **No. 409**: 1/4 to 3/8" L. 25 mm
 3 QuickRelease extensions 3/8" **No. 426QR**: L. 75; 160; 240 mm
 1 Wobble-Drive extension 3/8" **No. 427W**: L. 76 mm
 1 QuickRelease universal joint 3/8" **No. 428/1QR**: L. 60 mm
 1 QuickRelease fine-tooth ratchet 3/8" **No. 435QR N**: L. 193 mm
 1 square drive adaptor **No. 431**: 3/8 to 1/4
 1 square drive adaptor **No. 432**: 3/8 to 1/2"
 1 square drive adaptor **No. 513**: 1/2 to 3/8"

96830304

6 socket sockets TORX® 1/2" **No. 50TX**: E12; E14; E16; E18; E20; E24
 20 1/2" sockets with hex **No. 52**: 10; 11; 12; 13; 14; 15; 16; 17; 18; 19; 20; 21; 22; 23; 24; 26; 27; 28; 30; 32 mm
 7 screwdriver sockets INHEX 1/2" **No. 54**: 6; 7; 8; 10; 12; 14; 17 mm 7 screwdriver sockets 1/2" **No. 54X**: M5; M6; M8; M10; M12; M14; M16 8 screwdriver sockets 1/2" **No. 54TX**: T27; T30; T40; T45; T50; T55; T60; T70
 1 Wobble-Drive extension 1/2" **No. 509W**: L. 52 mm
 2 QuickRelease socket extensions, with countersunk head 1/2" **No. 503QR**: L. 130; 250 mm
 1 QuickRelease universal joint 1/2" **No. 510QR**: L. 80 mm
 1 flexible handle 1/2" **No. 504-2K**: L. 397 mm
 1 QuickRelease fine-tooth ratchet 1/2" **No. 512QR N80**: L. 265.5 mm
 1 telescopic ratchet 1/2" **No. 516**: L. 410 - 630 mm
 3 IMPACT socket sockets 1/2" **No. 51IMP**: 17; 19; 21 mm

96830305

4 slotted screwdrivers **No. 4622**: 1.0 x 5.5 x 100; 1.2 x 6.5 x 125; 1.6 x 10.0 x 175; 2.0 x 12.0 x 200 mm
 1 cross-head screwdriver DRALL+ **No. 4630**: PH1
 1 DRALL+ cross-head screwdriver **No. 4632**: PH3
 10 TORX® screwdrivers **No. 4650**: T6; T7; T8; T9; T10; T15; T20; T25; T27; T30
 1 slotted screwdriver **No. 4724**: 1.0 x 5.5 x 25 mm
 1 cross-head screwdriver **No. 4734**: PH2
 1 x 1/4" bit ratchet screwdriver **No. 4008-1**: L. 250 mm
 1 bit ratchet screwdriver 1/4" **No. 4008-2**: L. 95 mm
 1 bit box **No. 1206**: 1 bit holder | L. 25 mm: SL4;5;6 mm (2x) | PH1;2;3 (3x) | PZ1;2;3 (3x) | T10;15;20;25;27;30;40 (2x) | T B010;15;20;25;27;30;40 | INHEX 3;4;5 mm | L. 75 mm: SL6 mm | PH2;3 | PZ1;2 | T20;25 | 56 pieces

96830306

2 circlip pliers for internal circlips **No. 6543, 6544**: J2; J21
 2 circlip pliers for external circlips **No. 6545, 6546**: A2; A21
 1 water pump pliers **No. 6572**: L. 240 mm
 1 combination pliers **No. 6700**: L. 180 mm

1 heavy-duty side cutters **No. 6721**: L. 160 mm
1 telephone pliers **No. 6730**: L. 200 mm
1 telephone pliers **No. 6731**: L. 200 mm
5 plastic scrapers **No. 10677-10681**: wide, medium, narrow, slanted, tip blade
1 work light **No. 13134**: 500, 300, 100 lm
1 hex L-Key set **No. 10767/9**: 1.5; 2; 2.5; 3; 4; 5; 6; 8; 10 mm
1 STAHLWILLE bottle opener: L. 135 mm

96830307

20 combination spanners **No. 13**: 6; 7; 8; 9; 10; 11; 12; 13; 14; 15; 16; 17; 18; 19; 21;
22; 24; 27; 30; 32 mm
3 double-ended open-ring spanners, open angled **No. 24**: 8 x 10; 11 x 13; 12 x 14
mm
15 combination ratchet spanners **No. 17**: 8; 9; 10; 11; 12; 13; 14; 15; 16; 17; 18; 19;
21; 22; 24 mm

96830308

1 brake caliper brush **No. 12373**: L. 230 mm
1 telescopic stainless steel mirror **No. 12921M**: L. 178-921 mm
1 automotive circuit tester **No. 12905**: 6-12 + 24 V
1 tyre-tread caliper **No. 12900/3**: 0-30 mm
1 vernier caliper **No. 12900**: Measuring range: 150/6 mm
2 magnet lifter **No. 12600**: 270; 500 g
1 cable knife **No. 12320**: 111 mm
1 precision feeler gauge, 13 leaves **No. 11095-11097**: 0.05-1 mm
1 lever bar **No. 11006**: L. 400 mm
1 gasket scraper **No. 12718**: L. 265 mm
1 nylon hammer **No. 10956**: 75 Shore
1 engineer's hammer **No. 10961**: 500 g
5 pin punches **No. 108**: 3; 4; 5; 6; 8 mm
1 centre punch **No. 105**: 120 mm
2 flat chisels **No. 102**: 150; 200 mm
1 universal self-grip wrench **No. 6563**: L. 250 mm

Benefits.

Heavy-duty, robust tool trolley with 8 fully extendable drawers and central locking, including 349-piece tool set.

Patented QuickRelease locking system secures all components, from the ratchet to the extension to the socket.

The tools are securely integrated in durable, chemical-resistant TCS inlays with precise recesses and colour-coded signal areas.

Extensive automotive range with fine-tooth ratchets, sockets up to 32 mm, measuring and testing tools, screwdrivers, pliers and much more.

The durable 95/8 tool trolley has a static load capacity of up to 750 kg - the bottom drawer has a load capacity of up to 45 kg.

Product highlights.



PRODUCT IMAGE
IN PROGRESS

Complete solution for automotive and industrial applications.

Our comprehensive tool set offers the right solution for professional applications in the automotive and industrial sectors: whether replacing spark plugs, loosening stubborn bolted joints on axle or chassis components, performing electrical testing or maintenance work on machines. It includes fine-tooth ratchets with QuickRelease, sockets in 1/4", 3/8" and 1/2" up to 32 mm, a versatile bit set, long spark plug sockets, precise measuring and testing tools, a wide selection of screwdrivers and pliers, and numerous special tools. This equipment provides a reliable basis for all daily tasks in the workshop and in industrial environments.



Takes on anything.

High-quality materials such as the tightly welded stainless steel tray with a scratch-resistant honeycomb structure ensure the durability typical of STAHLWILLE and prevent liquids from penetrating into the interior of the trolley. The work surface of 827 x 496 mm is particularly suitable for working on large components. Thanks to its robust construction, the 95 PRO has a static load capacity of 750 kg. Thanks to reinforcements, the drawers can be loaded with 30 kg and the bottom drawer with up to 45 kg.



Full configuration as standard.

Whether paper roll and spray can holders, all-round impact protection with shock absorption, perforations on both sides for attaching accessories, locking brakes or oil and acid-resistant smooth-running castors (Ø 125 mm) with thread protection. Our tool trolley comes with many features as standard.

Technologies and features.

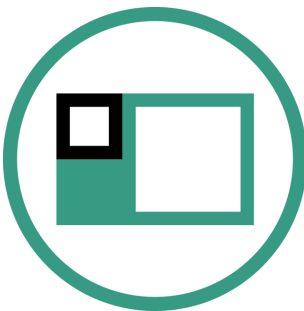

Modular Inlay System

This flexible solution for tool storage makes it possible to customise your tool trolleys and workbenches with 1/6, 1/3, 2/3 or 3/3 foam inlays.



Tool Control System

The intelligent modular inlay system protects and organises the tools in tool boxes, tool trolleys and workbenches. Two-colour foam inlays make checking the completeness of the tools quick and easy.

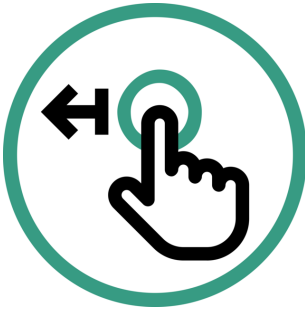

QuickRelease

The QuickRelease safety lock prevents unintentional loss of sockets and insert tools. These click securely into place, and are only released again at the push of a button for a quick tool change. In transducers: The QuickRelease safety lock helps you to quickly mount and change transducers. The transducers lock into the calibration system and only unlock again at the push of the buttons.



High Performance Quality (HPQ®)

Our HPQ® tool is made of wear-resistant high-performance steel, yet is thin-walled and lightweight. It withstands high torques and is ideal for work in confined spaces such as turbines.

Technical drawing.

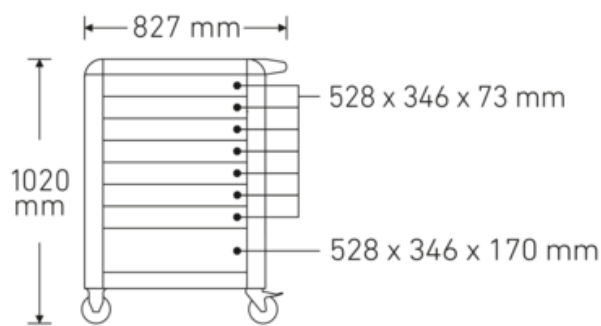
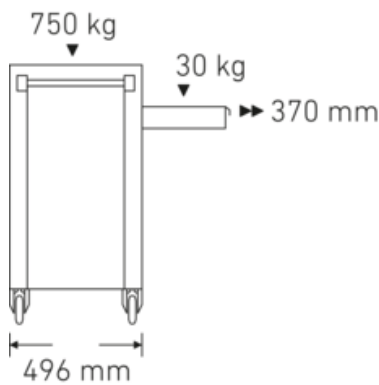

Technical attributes.

Length mm (L)	497 mm
Width mm (b)	823 mm
Height mm (h)	1021 mm
Number of drawers	8
Colour	anthracite, RAL 7016
Number of tools	349 pcs.

Logistics data.

Product no.	98830243
GTIN	4018754363049
Weight (g)	101000 g
Volume (packaged, dm ³)	652.8 dm ³
Packing standard	1
WEEE/ElektroG	nicht ear-pflichtig
Customs tariff no.	82060000
Country of origin AWR	GERMANY
Region of origin	Nordrhein-Westfalen
Depth mm (IFS)	800
Width mm (IFS)	600
Height mm (IFS)	1360
Weight (gross, kg)	120,500

Weight PAP (kg)	7,500
Weight PVC (kg)	0,000
Length (packaged, mm)	800
Width (packaged, mm)	600
Height (packaging, mm)	1360

Parts list.



01010004
Socket



01010005
Socket



01010006
Socket



01010007
Socket



01010008
Socket



01010009
Socket



01010010
Socket



01010011
Socket



01010012
Socket



01010013
Socket



01010014
Socket



01010045
Socket



01010055
Socket



01020004
Socket



01020005
Socket



01020006
Socket



01020007
Socket



01020008
Socket



01020009
Socket



01020010
Socket



01020011
Socket



01020012
Socket



01020013
Socket



01020045
Socket



01020055
Socket



01050003
INHEX screwdriver
socket



01050004
INHEX screwdriver
socket



01050005
INHEX screwdriver
socket



01050006
INHEX screwdriver
socket



01050025
INHEX screwdriver
socket



01140006
Uniflex sockets



01140008
Uniflex sockets



01140010
Uniflex sockets



01270004
Socket



01270005
Socket



01270006
Socket



01270007
Socket



01270008
Socket



01270010
Socket



01290001
Screwdriver socket



01290002
Screwdriver socket



01300001
Screwdriver socket



01300002
Screwdriver socket



01351008
Screwdriver socket



01351009
Screwdriver socket



01351010
Screwdriver socket



01351015
Screwdriver socket



01351020
Screwdriver socket



01351025
Screwdriver socket



01351027
Screwdriver socket



01351030
Screwdriver socket



02010010
Socket



02010011
Socket



02010012
Socket



02010013
Socket



02010014
Socket



02010015
Socket



02010016
Socket



02010017
Socket



02010018
Socket



02010019
Socket



02010020
Socket



02010021
Socket



02010022
Socket



02020010
Socket



02020011
Socket



02020012
Socket



02020013
Socket



02020014
Socket



02020015
Socket



02020016
Socket



02020017
Socket



02020018
Socket



02020019
Socket



02020021
Socket



02020022
Socket



02050006
INHEX screwdriver
socket



02050007
INHEX screwdriver
socket



02050008
INHEX screwdriver
socket



02050010
INHEX screwdriver
socket



02060005
Screwdriver socket



02060006
Screwdriver socket



02060008
Screwdriver socket



02060010
Screwdriver socket



02100025
Screwdriver socket



02100027
Screwdriver socket



02100030
Screwdriver socket



02100040
Screwdriver socket



02100045
Screwdriver socket



02110010
Socket



02110011
Socket



02110012
Socket



02110013
Socket



02110014
Socket



02110015
Socket



02110016
Socket



02110017
Socket



02110018
Socket



02110019
Socket



02110020
Socket



02110021
Socket



02110022
Socket



02120036
Spark plug socket



02130018
Spark plug socket



02151007
INHEX screwdriver
socket



02151009
INHEX screwdriver
socket



02270008
Socket



02270010
Socket



02270012
Socket



02270014
Socket



03030010
Socket



03030011
Socket



03030012
Socket



03030013
Socket



03030014
Socket



03030015
Socket



03030016
Socket



03030017
Socket



03030018
Socket



03030019
Socket



03030020
Socket



03030021
Socket



03030022
Socket



03030023
Socket



03030024
Socket



03030026
Socket



03030027
Socket



03030028
Socket



03030030
Socket



03030032
Socket



03050006
INHEX screwdriver
socket

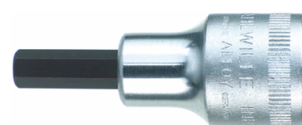

03050007
INHEX screwdriver
socket



03050008
INHEX screwdriver
socket



03050010
INHEX screwdriver
socket



03050012
INHEX screwdriver
socket



03050014
INHEX screwdriver
socket



03050017
INHEX screwdriver
socket



03060005
Screwdriver socket



03060006
Screwdriver socket



03060008
Screwdriver socket



03060010
Screwdriver socket



03060012
Screwdriver socket



03060014
Screwdriver socket

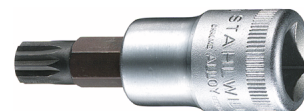

03060016
Screwdriver socket



03100027
Screwdriver socket



03100030
Screwdriver socket



03100040
Screwdriver socket



03100045
Screwdriver socket



03100050
Screwdriver socket



03100055
Screwdriver socket



03100060
Screwdriver socket



03100070
Screwdriver socket



03270012
Socket



03270014
Socket



03270016
Socket



03270018
Socket



03270020
Socket



03270024
Socket



11010020
Wobble-Drive extension



11011502
QR extensions



11011504
QR extensions



11011506
QR extensions



11021500
QuickRelease universal
joint



11030002
Square drive adaptor



11040000
Flexible extension



11111020
QR fine-tooth ratchet



11180010
Bit holder



11261010
QR fine-tooth flexible ratchet



12010007
Wobble-Drive extension



12011503
QR extensions



12011506
QR extensions



12011510
QR extensions



12021500
QuickRelease universal joint



12030001
Square drive adaptor



12030003
Square drive adaptor



12111020
QR fine-tooth ratchet



13010005
Wobble-Drive extension



13011505
QR extensions



13011510
QR extensions



13021000
QR universal joint



13030002
Square drive adaptor



13061015
Flexible handle



13111120
QR fine-tooth ratchet



13160000
Telescopic ratchet



18120001
Bit ratchet screwdriver



18120002
Bit ratchet screwdriver



23021017
IMPACT wheel nut socket



23021019
IMPACT wheel nut socket



23031021
IMPACT wheel nut
socket



40080606
Combination spanner



40080707
Combination spanner



40080808
Combination spanner



40080909
Combination spanner



40081010
Combination spanner



40081111
Combination spanner



40081212
Combination spanner



40081313
Combination spanner



40081414
Combination spanner



40081515
Combination spanner



40081616
Combination spanner



40081717
Combination spanner



40081818
Combination spanner



40081919
Combination spanner



40082121
Combination spanner



40082222
Combination spanner



40082424
Combination spanner



40082727
Combination spanner



40083030
Combination spanner



40083232
Combination spanner



41080810
Double-ended open-
ing spanner, angled



41081113
Double-ended open-
ing spanner, angled



41081214
Double-ended open-
ing spanner, angled



41170808
Combination ratchet
spanner



41170909
Combination ratchet
spanner



41171010
Combination ratchet
spanner



41171111
Combination ratchet
spanner



41171212
Combination ratchet
spanner



41171313
Combination ratchet
spanner



41171414
Combination ratchet
spanner



41171515
Combination ratchet
spanner



41171616
Combination ratchet
spanner



41171717
Combination ratchet
spanner



41171818
Combination ratchet
spanner



41171919
Combination ratchet
spanner



41172121
Combination ratchet
spanner



41172222
Combination ratchet
spanner



41172424
Combination ratchet
spanner



46223500
Slotted screwdriver
DRALL+



46223520
Slotted screwdriver
DRALL+



46223555
Slotted screwdriver
DRALL+



46223565
Slotted screwdriver
DRALL+



46303001
PH cross-head
screwdriver DRALL+



46323303
PH cross-head
screwdriver DRALL+



46503006
TORX® screwdriver
DRALL+



46503007
TORX® screwdriver
DRALL+



46503008
TORX® screwdriver
DRALL+



46503009
TORX® screwdriver
DRALL+



46503010
TORX® screwdriver
DRALL+



46503015
TORX® screwdriver
DRALL+



46503020
TORX® screwdriver
DRALL+



46503025
TORX® screwdriver
DRALL+



46503027
TORX® screwdriver
DRALL+



46503030
TORX® screwdriver
DRALL+



47241060
Slotted screwdriver
DRALL®



47341002
PH cross-head
screwdriver DRALL®



65434102
Circlip pliers for
internal circlips



65444121
Circlip pliers for
internal circlips



65454102
Circlip pliers for
external circlips



65464121
Circlip pliers for
external circlips



65632250
Universal self-grip
wrench



65726240
Water pump pliers
FastGRIP



67001180
Combination pliers



67211160
Heavy-duty side cutter



67301200
Telephone pliers



67311200
Telephone pliers



70020003
Flat chisel



70020005
Flat chisel



70050005
Centre punch



70070002
Pin punch



70070003
Pin punch



70070004
Pin punch



70070005
Pin punch



70070006
Pin punch



70110011
Engineer's hammer



70171035
Nylon hammer



72033101
Gasket scraper



72060200
Plastic scraper



72060201
Plastic scraper



72060202
Plastic scraper



72060203
Plastic scraper



72060204
Plastic scraper



72090002
Lever bar



74240001
Precision feeler gauge



77020000
Cable knife



77260025
Magnetic lifter

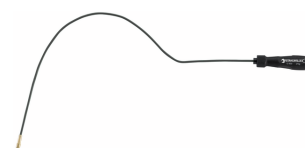

77260027
Magnetic lifter



77301020
Bottle opener

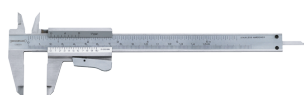

77371001
Caliper



77371004
Tyre-tread caliper



77380001
Automotive circuit tester



77401032
Telescopic stainless steel mirror



77440001
Brake caliper brush



77490016
Work light



96080156
Bit box

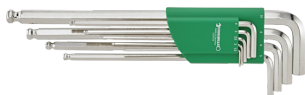

96432600
Hex ball-ended L-Key
set

GTIN.



Images.

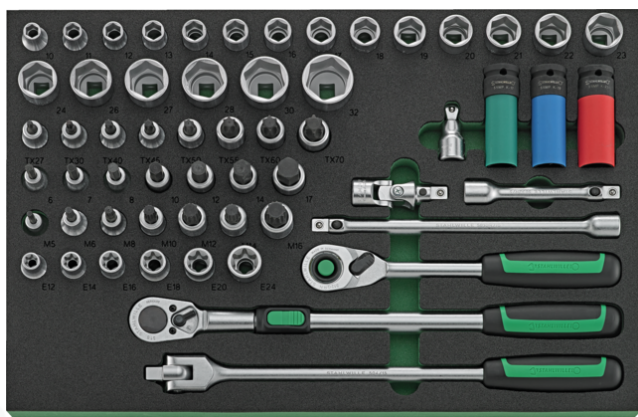
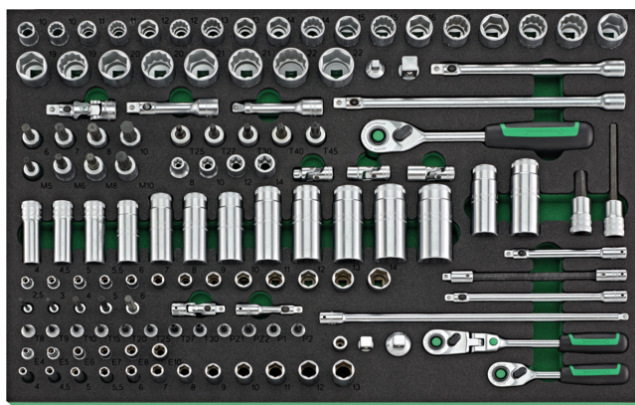

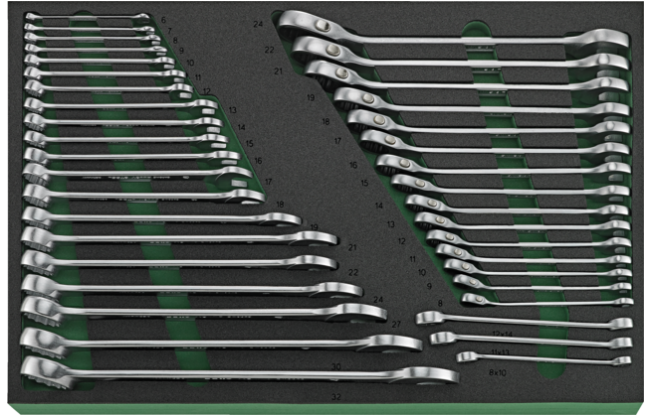

STAHLWILLE Eduard Wille GmbH

Lindenallee 27 · 42349 Wuppertal · Germany · Phone: +49 202 4791-0

info@stahlwille.de · www.stahlwille.com

© STAHLWILLE Eduard Wille GmbH, Wuppertal