



Ball joint separator

11701

Product no. **71070001**
GTIN **4018754342372**
Model **11701**

Label.

Ball joint separator Fork opening 20mm

Properties.

- for quick and reliable pressing out of ball joint pins from track rods and stabilisers
- for car and truck ball joints
- 2-way adjustable
- body and lever made from tempered steel
- drop-forged, hardened and tempered

Benefits.

For quick and reliable pressing out of ball joint pins from track rods, stabilisers etc.

Flexible use thanks to the two-stage lever adjustment option.

The body and the lever are made from high-strength heat-treated steel and are drop-forged.

Makes it easy to disassemble the ball joints of track rods of cars and lorries, and is suitable for the most popular vehicle makes.

Practical handling thanks to the slim fork.

Product highlights.



Reliable sliding properties.

The high-quality tempered and specially coated pressure spindle has particularly good sliding properties in the thread, is maintenance-free and does not require oiling.



Flexible use.

With the two-stage lever adjustment, this ball joint extractor can be conveniently adapted to different joint sizes and types. It also minimises the risk of damage to surrounding parts during use.



Robust construction.

The tool is made of high-quality steel and drop-forged, which gives it high stability and resistance to continuous use.

Technical drawing.

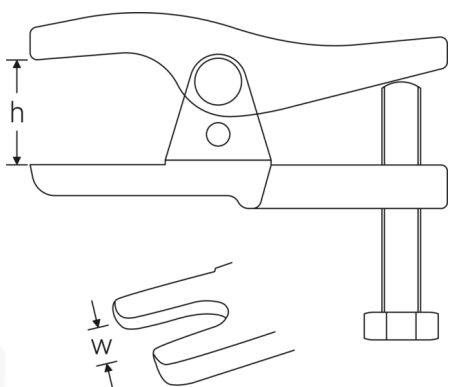

Technical attributes.

External hex drive (mm)	24 mm
Fork opening (w)	20 mm
Clear height (h) mm	12-50 mm

Logistics data.

Product no.	71070001
GTIN	4018754342372
Weight (g)	1370 g

Volume (packaged, dm3)	1.6416 dm3
Packing standard	1
WEEE/ElektroG	nicht ear-pflichtig
Customs tariff no.	82055980
Country of origin AWR	GERMANY
Region of origin	Nordrhein-Westfalen
Depth mm (IFS)	155
Width mm (IFS)	110
Height mm (IFS)	50
Weight (gross, kg)	1,260
Weight PAP (kg)	0,010
Weight PVC (kg)	0,000
Length (packaged, mm)	180
Width (packaged, mm)	120
Height (packaging, mm)	76

GTIN.



Images.

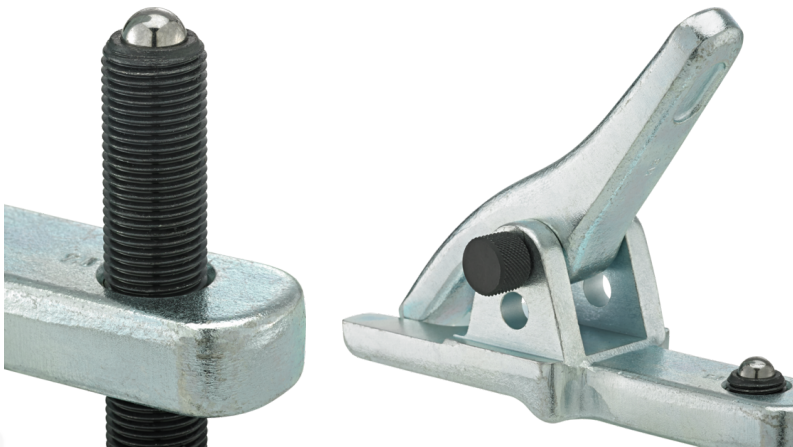

STAHLWILLE Eduard Wille GmbH

Lindenallee 27 · 42349 Wuppertal · Germany · Phone: +49 202 4791-0

info@stahlwille.de · www.stahlwille.com

© STAHLWILLE Eduard Wille GmbH, Wuppertal