



## Set di utensili con carrello da officina, 349 pezzi

**95/349QR**

Nr. art. **98830243**  
GTIN **4018754363049**  
Modello **95/349QR**



### Designazione.

Set di utensili con carrello da officina 95/349QR Cassetto8 antracite, RAL 7016 349 pzc.

### Proprietà.

#### Caratteristiche principali carrello da officina

- concetto di sicurezza a tre livelli:
  - chiusura centralizzata tramite serratura a cilindro laterale con chiave ribaltabile
  - la chiusura singola impedisce l'apertura accidentale durante il trasporto
  - protezione antiribaltamento: non è possibile estrarre contemporaneamente più cassetti.
- maniglia in acciaio verniciato nero con collegamento rinforzato al corpo
- protezione per rami su tutto il perimetro con ammortizzatore d'urto
- piano di lavoro e ripiano resistente saldato ermeticamente
- ruote scorrevoli resistenti all'olio e agli acidi (Ø ruote 125 mm) con protezione contro i fili per proteggere i cuscinetti dallo sporco e dai fili, con due freni di bloccaggio
- supporto per rotoli di carta e bombolette spray incluso
- 8 cassetti facilmente estraibili (neri RAL 9005) con estrazione totale e guida a gabbia sferica
- griglia forata su entrambi i lati per ganci N. 8031-8041, ad es. per utensili di grandi dimensioni
- attrezzabile con inserti standard STAHLWILLE e inserti TCS
- sicurezza garantita grazie al sistema modulare Tool Control System (TCS)

1 carrello da officina **N. 95/8 A PRO**: 8 cassetti

#### Contiene 349 pezzi:

**96830303**

13 chiavi a bussola 1/4" con esagonale **N. 40**: 4; 4,5; 5; 5,5; 6; 7; 8; 9; 10; 11; 12; 13; 14 mm

12 chiavi a bussola lunghe, con esagonale 1/4" **N. 40L**: 4; 4,5; 5; 5,5; 6; 7; 8; 9; 10; 11; 12; 13 mm

6 chiavi a bussola 1/4" TORX® **N. 40TX**: E4; E5; E6; E7; E8; E10

5 inserti per giravite INHEX 1/4" **N. 44**: 3 (2x); 4; 5; 6 mm

2 inserti per giravite a croce 1/4" **N. 44PH**: PH1; PH2

2 inserti per cacciavite 1/4" a croce **N. 44PZ**: PZ1; PZ2

8 inserti per cacciaviti TORX® 1/4" **N. 44KTXB**: T8; T9; T10; T15; T20; T25; T27; T30

3 bussole snodate per candele 1/4" **N. 402**: 6; 8; 10 mm

1 prolunga Wobble Drive 1/4" **N. 405W**: L. 254 mm

3 prolunghe QuickRelease 1/4" **N. 408QR**: L. 55; 99; 150 mm  
1 giunto universale QuickRelease 1/4" **N. 407/1QR**: L. 45 mm  
1 prolunga flessibile 1/4" **N. 406**: L. 152 mm  
1 portapunta 1/4" **N. 412**: L. 25 mm  
1 cricchetto a denti fini QuickRelease 1/4" **N. 415QR N**: L. 117 mm  
1 cricchetto articolato QuickRelease a denti fini 1/4" **N. 416QR**: L. 170 mm  
4 inserti per chiavi a bussola TORX® 3/8" **N. 45TX**: E8; E10; E12; E14  
12 prese esagonali lunghe, con doppio esagono 3/8" **N. 46**: 10; 11; 12; 13; 14; 15; 16;  
17; 18; 19; 21; 22 mm  
4 inserti per giravite 3/8" per viti INHEX **N. 49**: 6; 7; 8; 10 mm  
4 inserti per giravite XZN® 3/8" **N. 49X**: M5; M6; M8; M10  
5 inserti per giravite TORX® 3/8" **N. 49TX**: T25; T27; T30; T40; T45  
26 chiavi a bussola con esagonale 3/8" **N. 456**: 10; 11; 12; 13; 14; 15; 16; 17; 18; 19;  
20; 21; 22 mm (2x ciascuno)  
1 presa esagonale lunga, con doppio esagono e inserto in gomma 3/8" **N. 4600**: 16  
mm-5/8"  
1 bussola snodata per candele lunga, con esagono e inserto in gomma 3/8" **N. 4606**:  
18 mm/ 11/16"  
2 inserti per giravite INHEX 3/8" **N. 1049**: 7; 9 mm  
1 adattatore attacco quadro 3/8" **N. 409**: 1/4 su 3/8" L. 25 mm  
3 prolunghe QuickRelease 3/8" **N. 426QR**: L. 75; 160; 240 mm  
1 prolunga Wobbel Drive 3/8" **N. 427W**: L. 76 mm  
1 giunto universale QuickRelease 3/8" **N. 428/1QR**: L. 60 mm  
1 cricchetto a denti fini QuickRelease 3/8" **N. 435QR N**: L. 193 mm  
1 riduttore **N. 431**: da 3/8 a 1/4"  
1 adattatore attacco quadro **N. 432**: da 3/8 a 1/2"  
1 riduttore **N. 513**: da 1/2 a 3/8"

#### 96830304

6 chiavi a bussola TORX® 1/2" **N. 50TX**: E12; E14; E16; E18; E20; E24  
20 chiavi a bussola 1/2" con esagonale **N. 52**: 10; 11; 12; 13; 14; 15; 16; 17; 18; 19;  
20; 21; 22; 23; 24; 26; 27; 28; 30; 32 mm  
7 inserti per giravite INHEX 1/2" **N. 54**: 6; 7; 8; 10; 12; 14; 17 mm  
7 inserti per giravite 1/2" **N. 54X**: M5; M6; M8; M10; M12; M14; M16  
8 inserti per giravite 1/2" **N. 54TX**: T27; T30; T40; T45; T50; T55; T60; T70  
1 prolunga Wobble Drive 1/2" **N. 509W**: L. 52 mm  
2 prolunghe per chiavi a bussola QuickRelease, con testa incassata 1/2" **N. 503QR**:  
L. 130; 250 mm  
1 giunto universale QuickRelease 1/2" **N. 510QR**: L. 80 mm  
1 maniglia articolata 1/2" **N. 504-2K**: L. 397 mm  
1 cricchetto a denti fini QuickRelease 1/2" **N. 512QR N**: L. 265,5 mm  
1 chiave telescopica per inserti 1/2" **N. 516**: L. 410 - 630 mm  
3 chiavi a bussola IMPACT 1/2" **N. 51IMP**: 17; 19; 21 mm

#### 96830305

4 giraviti a taglio **N. 4622**: 1,0 x 5,5 x 100; 1,2 x 6,5 x 125; 1,6 x 10,0 x 175; 2,0 x 12,0  
x 200 mm  
1 cacciavite a croce DRALL+ **N. 4630**: PH1  
1 cacciavite a croce DRALL+ **N. 4632**: PH3  
10 cacciaviti TORX® **N. 4650**: T6; T7; T8; T9; T10; T15; T20; T25; T27; T30  
1 giravite a taglio **N. 4724**: 1,0 x 5,5 x 25 mm  
1 giravite a croce **N. 4734**: PH2  
1 cacciavite a cricchetto con punta a brugola 1/4" **N. 4008-1**: L. 250 mm  
1 cacciavite a cricchetto con 1 bit 1/4" **N. 4008-2**: L. 95 mm  
1 scatola portapunte N. 1206: 1 portapunta | L. 25 mm: SL4;5;6 mm (2x) | PH1;2;3  
(3x) | PZ1;2;3 (3x) | T10;15;20;25;27;30;40 (2x) | T B010;15;20;25;27;30;40 | INHEX  
3;4;5 mm | L. 75 mm: SL6 mm | PH2;3 | PZ1;2 | T20;25 | 56 pezzi

### 96830306

2 pinze per anelli di sicurezza per anelli interni **N. 6543, 6544:** J2; J21  
2 pinze per anelli di sicurezza per anelli esterni **N. 6545, 6546:** A2; A21  
1 pinza regolabile **N. 6572:** L. 240 mm  
1 pinza combinata **N. 6700:** L. 180 mm  
1 tronchese per tubi **N. 6721:** L. 160 mm  
1 pinza telefonica **N. 6730:** L. 200 mm  
1 pinza per telefoni **N. 6731:** L. 200 mm  
5 raschietti in plastica **N. 10677-10681:** lama larga, media, stretta, obliqua, a punta  
1 luce da lavoro **N. 13134:** 500, 300, 100 lm  
1 set di chiavi a L esagonali **N. 10767/9:** 1,5; 2; 2,5; 3; 4; 5; 6; 8; 10 mm  
1 apribottiglie STAHLWILLE: L. 135 mm

### 96830307

20 chiave combinata **N. 13:** 6; 7; 8; 9; 10; 11; 12; 13; 14; 15; 16; 17; 18; 19; 21; 22; 24; 27; 30; 32 mm  
3 chiavi doppie a cassetta, aperte angolate **N. 24:** 8 x 10; 11 x 13; 12 x 14 mm  
15 chiavi ad anello a cricchetto **N. 17:** 8; 9; 10; 11; 12; 13; 14; 15; 16; 17; 18; 19; 21; 22; 24 mm

### 96830308

1 spazzola per pinza freno **N. 12373:** L. 230 mm  
1 specchio telescopico in acciaio inox **N. 12921M:** L. 178-921 mm  
1 tester di circuito per automobili **N. 12905:** 6-12 + 24 V  
1 calibro per pneumatici **N. 12900/3:** 0-30 mm  
1 pinza **N. 12900:** intervallo di misura: 150/6 mm/"  
2 sollevatori magnetici **N. 12600:** 270; 500 g  
1 coltello per cavi **N. 12320:** 111 mm  
1 spessimetro di precisione, 13 lame di taglio **N. 11095-11097:** 0,05-1 mm  
1 leva **N. 11006:** L. 400 mm  
1 raschietto per guarnizioni **N. 12718:** L. 265 mm  
1 martello in nylon **N. 10956:** 75 Shore  
1 martello tipo tedesco **N. 10961:** 500 g  
5 punzoni a spillo **N. 108:** 3; 4; 5; 6; 8 mm  
1 punzone centrale **N. 105:** 120 mm  
2 scalpelli piatti **N. 102:** 150; 200 mm  
1 pinza universale **N. 6563:** L. 250 mm

## Vantaggi.

Carrello portautensili resistente e robusto con 8 cassette completamente estraibili e chiusura centralizzata, incl. set di utensili da 349 pezzi.

Il sistema di bloccaggio brevettato QuickRelease blocca tutti i componenti, dal cricchetto alla prolunga fino alla chiave a bussola.

Gli utensili sono integrati in modo sicuro in inserti TCS resistenti alle sostanze chimiche con precisione e superficie di segnalazione colorata.

Ampio assortimento per autoveicoli con cricchetto a denti fini, chiavi a bussola fino a 32 mm, strumenti di misura e di test, cacciaviti, pinze e molto altro ancora.

Il robusto carrello da officina 95/8 ha una portata statica fino a 750 kg, mentre il cassetto inferiore ha una capacità di carico fino a 45 kg.

## Prodotti in evidenza.



PRODUCT IMAGE  
IN PROGRESS

### Soluzione completa per il settore automobilistico e industriale.

Il nostro vasto assortimento di utensili offre una soluzione adeguata per applicazioni professionali nel settore automobilistico e industriale: che si tratti di sostituire candele, allentare viti bloccate su componenti dell'asse o del telaio, eseguire controlli elettrici o lavori di manutenzione su macchine. Comprende, tra l'altro, cricchetti a denti fini con QuickRelease, bussole snodate da 1/4", 3/8" e 1/2" fino a 32 mm, un set di punte versatile, bussole snodate lunghe per candele, strumenti di misura e di test di precisione, un'ampia scelta di cacciaviti e pinze, nonché numerosi utensili speciali. Questa dotazione costituisce quindi una base affidabile per tutte le attività quotidiane in officina e in ambito industriale.



### All'altezza di tutto.

Materiali di alta qualità, come la vasca in acciaio inossidabile saldato a tenuta stagna con struttura a nido d'ape resistente ai graffi, garantiscono la durata tipica di STAHLWILLE e impediscono la penetrazione di liquidi all'interno del carrello. La superficie di lavoro di 827 x 496 mm è particolarmente adatta per lavorare su componenti di grandi dimensioni. Grazie alla sua struttura robusta, il 95 PRO raggiunge una capacità di carico statica di 750 kg. Grazie ai rinforzi, i cassetti possono essere caricati con 30 kg e il cassetto inferiore addirittura con 45 kg.



### Dotazione completa di serie.

Che si tratti di supporto per rotoli di carta e bombolette spray, protezione per rami con ammortizzatori, griglia forata su entrambi i lati per il fissaggio di accessori, freni di stazionamento o ruote scorrevoli resistenti all'olio e agli acidi (Ø 125 mm) con protezione anti-intreccio. Il nostro carrello portautensili offre numerose caratteristiche di serie.

## Tecnologie e caratteristiche.



### Modular Inlay System

Questa soluzione flessibile per lo stoccaggio degli utensili consente di personalizzare i carrelli da officina e i banchi da lavoro con inserti in schiuma 1/6, 1/3, 2/3 o 3/3.



### Tool Control System

L'intelligente sistema modulare di inserti protegge e organizza gli utensili in valigie porta utensili, carrelli e banchi da officina. Gli inserti in schiuma bicolore consentono di verificare la completezza degli utensili in modo rapido e semplice.



### QuickRelease

Il blocco di sicurezza QuickRelease impedisce la perdita accidentale degli utensili a innesto. Questi si bloccano saldamente in posizione e vengono rilasciati solo premendo un pulsante per una sostituzione rapida dell'utensile.



### High Performance Quality (HPQ®)

Il nostro utensile HPQ® è realizzato in acciaio ad alte prestazioni resistente all'usura, ma con pareti sottili e leggero. Resiste a coppie elevate ed è ideale per lavorare in spazi ristretti come le turbine.

## Disegno tecnico.

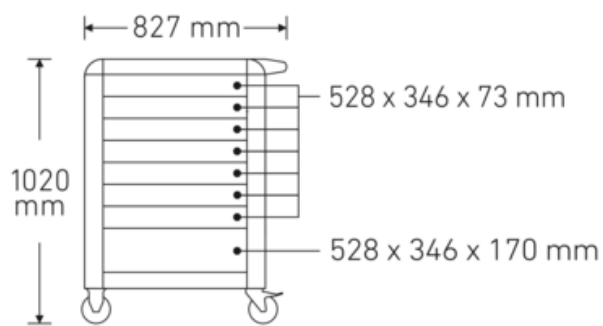
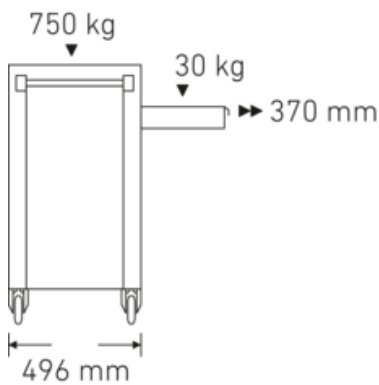

## Attributi tecnici.

Numero di cassette	8
Numero di utensili	349 pzc.
Larghezza mm (b)	823 mm
Codice colore	antracite, RAL 7016
Spessore mm (h)	1021 mm
Lunghezza mm (L)	497 mm

## Dati logistici.

Profondità mm (IFS)	800
Larghezza mm (IFS)	600
Spessore mm (IFS)	1360
RAEE/Legge sull'elettricità	nicht ear-pflichtig
Lunghezza (imballata, mm)	800
Larghezza (imballata, mm)	600
Spessore (confezionata, mm)	1360
Volume (imballato, dm <sup>3</sup> )	652.8 dm <sup>3</sup>
Nr. art.	98830243
Peso (lordo, kg)	120,500
Peso PAP (kg)	7,500
Peso PVC (kg)	0,000
GTIN	4018754363049

Paese di origine AWR

GERMANY

Regione di origine

Nordrhein-Westfalen

N. tariffa doganale

82060000

Standard di imballaggio

1

Peso (g)

101000 g

## Elenco delle parti.

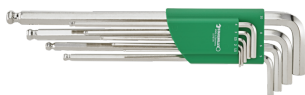

96432600  
Set di chiavi a L  
esagonali a testa  
sferica



96080156  
Assortimento inserti



77490016  
Lampada da lavoro



77440001  
Spazzola metallica



77401032  
Specchietto telescopico  
in acciaio inossidabile



77380001  
Tester di circuito per  
automobili



77371004  
Calibro per pneumatici



77371001  
Calibro



77301020  
Apribottiglie

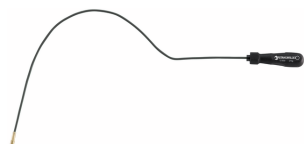

77260027  
Sollevatore magnetico



77260025  
Sollevatore magnetico



77020000  
Coltello per cavi



74240001  
Spessimetri di  
precisione



72090002  
Leva



72060204  
Raschietto in plastica



72060203  
Raschietto in plastica



72060202  
Raschietto in plastica



72060201  
Raschietto in plastica



72060200  
Raschietto in plastica



72033101  
Raschietto per  
guarnizioni



70171035  
Martello in nylon



70110011  
Martello tipo tedesco



70070006  
Cacciaspine



70070005  
Cacciaspine



70070004  
Cacciaspine



70070003  
Cacciaspine



70070002  
Cacciaspine



70050005  
Bulino



70020005  
Scalpello piatto



70020003  
Scalpello piatto



67311200  
Pinze a becchi lunghi



67301200  
Pinze a becchi lunghi



67211160  
Tronchese per uso  
intenso



67001180  
Pinza combinata



65726240  
Pinza regolabile  
FastGRIP



65632250  
Chiave autobloccante  
universale



65464121  
Pinze per anelli di  
sicurezza esterni



65454102  
Pinze per anelli di  
sicurezza esterni



65444121  
Pinze per anelli di  
sicurezza interni



65434102  
Pinze per anelli di  
sicurezza interni



61019199  
Termoformato TCS



61019198  
Termoformato TCS



61019197  
Termoformato TCS



61019195  
Termoformato TCS



61018855  
Termoformato TCS



61018847  
Termoformato TCS



47341002  
Giravite a croce PH  
DRALL®



47241060  
Giravite a taglio  
DRALL®



46503030  
Giravite TORX® DRALL+

46503027  
Giravite TORX® DRALL+

46503025  
Giravite TORX® DRALL+

46503020  
Giravite TORX® DRALL+



46503015  
Giravite TORX® DRALL+

46503010  
Giravite TORX® DRALL+

46503009  
Giravite TORX® DRALL+

46503008  
Giravite TORX® DRALL+



46503007  
Giravite TORX® DRALL+

46503006  
Giravite TORX® DRALL+

46323303  
Giravite a croce PH  
DRALL+

46303001  
Giravite a croce PH  
DRALL+



46223565  
Giravite a taglio  
semplice DRALL+

46223555  
Giravite a taglio  
DRALL+

46223520  
Giravite a taglio  
semplice DRALL+

46223500  
Giravite a taglio  
semplice DRALL+



41172424  
Chiave ad anello a  
cricchetto



41172222  
Chiave ad anello a  
cricchetto



41172121  
Chiave ad anello a  
cricchetto



41171919  
Chiave ad anello a  
cricchetto



41171818  
Chiave ad anello a  
cricchetto



41171717  
Chiave ad anello a  
cricchetto



41171616  
Chiave ad anello a  
cricchetto



41171515  
Chiave ad anello a  
cricchetto



41171414  
Chiave ad anello a  
cricchetto



41171313  
Chiave ad anello a  
cricchetto



41171212  
Chiave ad anello a  
cricchetto



41171111  
Chiave ad anello a  
cricchetto



41171010  
Chiave ad anello a  
cricchetto



41170909  
Chiave ad anello a  
cricchetto



41170808  
Chiave ad anello a  
cricchetto



41081214  
Chiave doppia ad anello  
aperto, angolata



41081113  
Chiave doppia ad anello  
aperto, angolata



41080810  
Chiave doppia ad anello  
aperto, angolata



40083232  
Chiave combinata



40083030  
Chiave combinata



40082727  
Chiave combinata



40082424  
Chiave combinata



40082222  
Chiave combinata



40082121  
Chiave combinata



40081919  
Chiave combinata



40081818  
Chiave combinata



40081717  
Chiave combinata



40081616  
Chiave combinata



40081515  
Chiave combinata



40081414  
Chiave combinata



40081313  
Chiave combinata



40081212  
Chiave combinata



40081111  
Chiave combinata



40081010  
Chiave combinata



40080909  
Chiave combinata



40080808  
Chiave combinata



40080707  
Chiave combinata



40080606  
Chiave combinata



23021021  
Chiave per dadi ruota  
IMPACT



23021019  
Chiave per dadi ruota  
IMPACT



23021017  
Chiave per dadi ruota  
IMPACT



18120002  
Giravite a cricchetto  
portainseriti



18120001  
Giravite a cricchetto  
con inserto



13160000  
Chiave telescopica per  
inserti



13111120  
Leva a cricco con  
dentatura fine QR



13061015  
Impugnatura a snodo

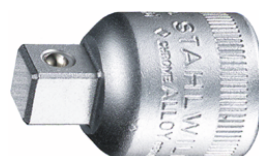

13030002  
Riduttore



13021000  
Snodo cardanico QR



13011510  
Prolunga QuickRelease



13011505  
Prolunga QuickRelease



13010005  
Prolunga chiave a  
bussola Wobble Drive



12111020  
Leva a cricco con  
dentatura fine QR



12030003  
Espansore



12030001  
Riduttore



12021500  
Giunto cardanico QR



12011510  
Prolunga QuickRelease



12011506  
Prolunga QuickRelease



12011503  
Prolunga QuickRelease



12010007  
Prolunga chiave a  
bussola Wobble Drive



11261010  
Cricco a snodo QR con  
dentatura fine



11180010  
Portainseriti



11111020  
Leva a cricco con  
dentatura fine QR



11040000  
Prolunga flessibile



11030002  
Espansore



11021500  
Giunto universale QR



11011506  
Prolunga QuickRelease



11011504  
Prolunga QuickRelease



11011502  
Prolunga QuickRelease



11010020  
Prolunga Wobble Drive



03270024  
Inserto chiave a  
bussola



03270020  
Inserto chiave a  
bussola



03270018  
Inserto chiave a  
bussola



03270016  
Inserto chiave a  
bussola



03270014  
Inserto chiave a  
bussola



03270012  
Inserto chiave a  
bussola



03100070  
Bussola a cacciavite



03100060  
Bussola a cacciavite



03100055  
Bussola a cacciavite



03100050  
Bussola a cacciavite



03100045  
Bussola a cacciavite



03100040  
Bussola a cacciavite



03100030  
Bussola a cacciavite



03100027  
Bussola a cacciavite



03060016  
Bussola a cacciavite



03060014  
Bussola a cacciavite



03060012  
Bussola a cacciavite



03060010  
Bussola a cacciavite

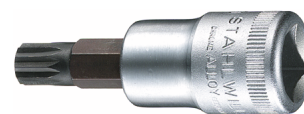

03060008  
Bussola a cacciavite



03060006  
Bussola a cacciavite



03060005  
Bussola a cacciavite



03050017  
Inserto cacciavite  
INHEX



03050014  
Inserto cacciavite  
INHEX



03050012  
Inserto cacciavite  
INHEX



03050010  
Inserto cacciavite  
INHEX



03050008  
Inserto cacciavite  
INHEX

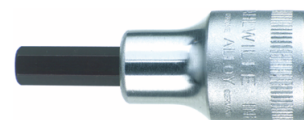

03050007  
Inserto cacciavite  
INHEX



03050006  
Inserto cacciavite  
INHEX



03030032  
Inserto chiave a  
bussola



03030030  
Inserto chiave a  
bussola



03030028  
Inserto chiave a  
bussola



03030027  
Inserto chiave a  
bussola



03030026  
Inserto chiave a  
bussola



03030024  
Inserto chiave a  
bussola



03030023  
Inserto chiave a  
bussola



03030022  
Inserto chiave a  
bussola



03030021  
Inserto chiave a  
bussola



03030020  
Inserto chiave a  
bussola



03030019  
Inserto chiave a  
bussola



03030018  
Inserto chiave a  
bussola



03030017  
Inserto chiave a  
bussola



03030016  
Inserto chiave a  
bussola



03030015  
Inserto chiave a  
bussola



03030014  
Inserto chiave a  
bussola



03030013  
Inserto chiave a  
bussola



03030012  
Inserto chiave a  
bussola



03030011  
Inserto chiave a  
bussola



03030010  
Inserto chiave a  
bussola



02270014  
Inserto chiave a  
bussola



02270012  
Inserto chiave a  
bussola



02270010  
Inserto chiave a  
bussola



02270008  
Inserto chiave a  
bussola



02151009  
Inserto cacciavite  
INHEX



02151007  
Inserto cacciavite  
INHEX



02130018  
Bussola per candele



02120036  
Bussola per candele



02110022  
Inserto chiave a  
bussola



02110021  
Inserto chiave a  
bussola



02110020  
Inserto chiave a  
bussola



02110019  
Inserto chiave a  
bussola



02110018  
Inserto chiave a  
bussola



02110017  
Inserto chiave a  
bussola



02110016  
Inserto chiave a  
bussola



02110015  
Inserto chiave a  
bussola



02110014  
Inserto chiave a  
bussola



02110013  
Inserto chiave a  
bussola



02110012  
Inserto chiave a  
bussola



02110011  
Inserto chiave a  
bussola



02110010  
Inserto chiave a  
bussola



02100045  
Bussola a cacciavite



02100040  
Bussola a cacciavite



02100030  
Bussola a cacciavite



02100027  
Bussola a cacciavite



02100025  
Bussola a cacciavite



02060010  
Bussola a cacciavite



02060008  
Bussola a cacciavite



02060006  
Bussola a cacciavite



02060005  
Bussola a cacciavite



02050010  
Inserto cacciavite  
INHEX



02050008  
Inserto cacciavite  
INHEX



02050007  
Inserto cacciavite  
INHEX



02050006  
Inserto cacciavite  
INHEX



02020022  
Chiave a bussola



02020021  
Chiave a bussola



02020019  
Chiave a bussola



02020018  
Chiave a bussola



02020017  
Chiave a bussola



02020016  
Chiave a bussola



02020015  
Chiave a bussola



02020014  
Chiave a bussola



02020013  
Chiave a bussola



02020012  
Chiave a bussola



02020011  
Chiave a bussola



02020010  
Chiave a bussola



01351030  
Bussola a cacciavite



01351027  
Bussola a cacciavite



01351025  
Bussola a cacciavite



01351020  
Bussola a cacciavite



01351015  
Bussola a cacciavite



01351010  
Bussola a cacciavite



01351009  
Bussola a cacciavite



01351008  
Bussola a cacciavite



01300002  
Bussola a cacciavite



01300001  
Bussola a cacciavite



01290002  
Bussola a cacciavite



01290001  
Bussola a cacciavite



01270010  
Inserto chiave a  
bussola



01270008  
Inserto chiave a  
bussola



01270007  
Inserto chiave a  
bussola



01270006  
Inserto chiave a  
bussola



01270005  
Inserto chiave a  
bussola



01270004  
Inserto chiave a  
bussola



01140010  
Bussola a snodo



01140008  
Bussola a snodo



01140006  
Bussola a snodo



01050006  
Inserto cacciavite  
INHEX



01050005  
Inserto cacciavite  
INHEX



01050004  
Inserto cacciavite  
INHEX



01050003  
Inserto cacciavite  
INHEX



01020055  
Inserto chiave a  
bussola



01020045  
Inserto chiave a  
bussola



01020013  
Inserto chiave a  
bussola



01020012  
Inserto chiave a  
bussola



01020011  
Inserto chiave a  
bussola



01020010  
Inserto chiave a  
bussola



01020009  
Inserto chiave a  
bussola



01020008  
Inserto chiave a  
bussola



01020007  
Inserto chiave a  
bussola



01020006  
Inserto chiave a  
bussola



01020005  
Inserto chiave a  
bussola



01020004  
Inserto chiave a  
bussola



01010055  
Inserto chiave a  
bussola



01010045  
Inserto chiave a  
bussola



01010014  
Inserto chiave a  
bussola



01010013  
Inserto chiave a  
bussola



01010012  
Inserto chiave a  
bussola



01010011  
Inserto chiave a  
bussola



01010010  
Inserto chiave a  
bussola



01010009  
Inserto chiave a  
bussola



01010008  
Inserto chiave a  
bussola



01010007  
Inserto chiave a  
bussola



01010006  
Inserto chiave a  
bussola



01010005  
Inserto chiave a  
bussola



01010004  
Inserto chiave a  
bussola



81200166  
Carrello da officina

## Varianti.

Nr. art.	Modello N. (ERP)	Designazione	GTIN
98830243	95/349QR	Set di utensili con carrello da officina 95/349QR Cassetto8 antracite, RAL 7016 349 pzc.	4018754363049

## Codice GTIN.



## Immagini.

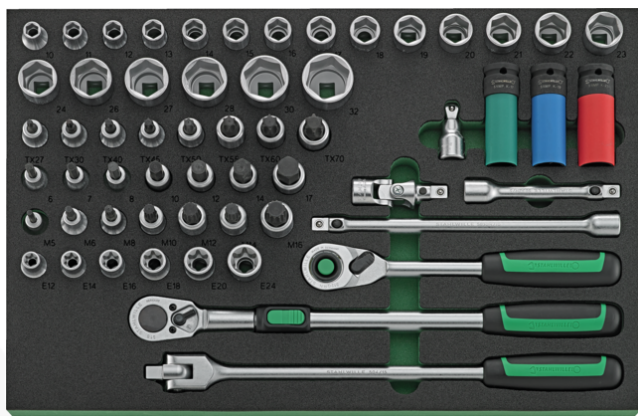
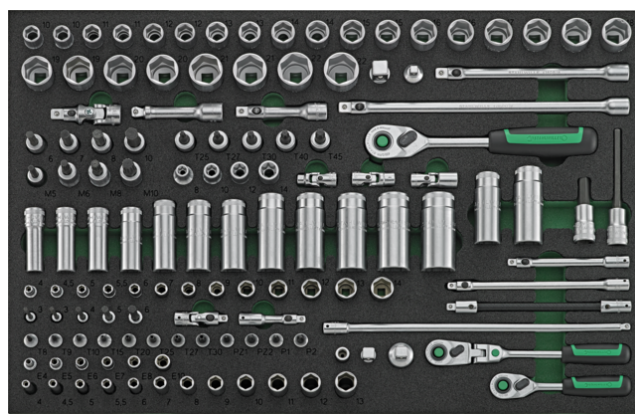

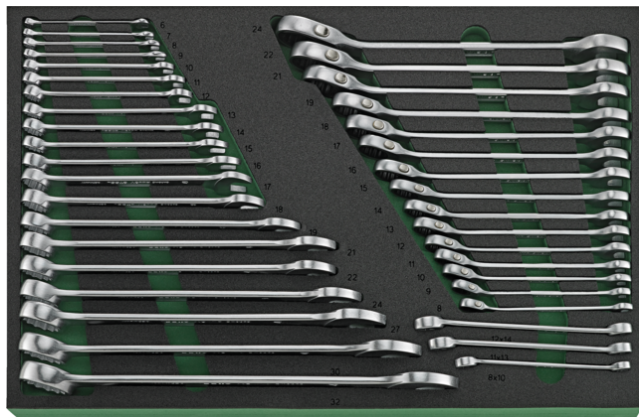

**STAHLWILLE Eduard Wille GmbH**

Lindenallee 27 · 42349 Wuppertal · Germania · Tel.: +49 202 4791-0

[info@stahlwille.de](mailto:info@stahlwille.de) · [www.stahlwille.com](http://www.stahlwille.com)

© STAHLWILLE Eduard Wille GmbH, Wuppertal