



## Tool set with tool trolley, 349 pieces

**95/349QR**

Product no. **98830243**  
GTIN **4018754363049**  
Model **95/349QR**



### Label.

Tool set with tool trolley 95/349QR Drawer8 anthracite, RAL 7016 349

### Properties.

#### Top features of the tool trolley

- three-stage security concept:
  - central locking via side cylinder lock with fold-down key
  - individual locking prevents accidental opening while driving
  - tilt protection - several drawers cannot be pulled out at the same time.
- black lacquered steel handle with reinforced body connection
- all-round impact protection with shock absorption
- tightly welded, resistant work and storage surface
- oil and acid-resistant, ball-bearing smooth-running castors (castor Ø 125 mm) with thread protection to protect the bearings from dirt and threads, with two locking brakes
- paper roll and spray can holder included
- 8 easily removable drawers (black RAL 9005) with full extension and ball cage guide
- perforation on both sides for hooks No. 8031-8041, e.g. for larger tools
- can be equipped with STAHLWILLE standard and TCS inlays
- safely integrated in the modular Tool Control System (TCS)

1 tool trolley **No. 95/8 A PRO**: 8 drawers

#### Contains 349-pieces:

**96830303**

13 sockets 1/4" with hex **No. 40**: 4; 4.5; 5; 5.5; 6; 7; 8; 9; 10; 11; 12; 13; 14 mm

12 long sockets with hex 1/4" **No. 40L**: 4; 4.5; 5; 5.5; 6; 7; 8; 9; 10; 11; 12; 13 mm

6 sockets 1/4" TORX® **No. 40TX**: E4; E5; E6; E7; E8; E10

5 INHEX screwdriver sockets 1/4" **No. 44**: 3 (2x); 4; 5; 6mm

2 screwdriver sockets, Phillips 1/4" **No. 44PH**: PH1; PH2

2 screwdriver sockets 1/4" Phillips **No. 44PZ**: PZ1; PZ2

8 screwdriver sockets TORX® 1/4" **No. 44KTXB**: T8; T9; T10; T15; T20; T25; T27; T30

3 flex sockets 1/4" **No. 402**: 6; 8, 10 mm

1 Wobble Drive extension 1/4" **No. 405W**: L. 254 mm

3 QuickRelease extensions 1/4" **No. 408QR**: L. 55; 99; 150 mm

1 QuickRelease universal joint 1/4" **No. 407/1QR**: L. 45 mm

1 flexible extension 1/4" **No. 406**: L. 152 mm

1 bit holder 1/4" **No. 412**: L. 25 mm

1 QuickRelease fine-tooth ratchet 1/4" **No. 415QR N**: L. 117 mm  
1 QuickRelease fine-tooth articulated ratchet 1/4" **No. 416QR**: L. 170 mm  
4 TORX® sockets 3/8" **No. 45TX**: E8; E10; E12; E14  
12 long sockets with bi-hex 3/8" **No. 46**: 10; 11; 12; 13; 14; 15; 16; 17; 18; 19; 21; 22 mm  
4 screwdriver sockets 3/8" for INHEX screws **No. 49**: 6; 7; 8; 10 mm  
4 screwdriver sockets XZN® 3/8" **No. 49X**: M5; M6; M8; M10  
5 screwdriver sockets TORX® 3/8" **No. 49TX**: T25; T27; T30; T40; T45  
26 hex sockets 3/8" **No. 456**: 10; 11; 12; 13; 14; 15; 16; 17; 18; 19; 20; 21; 22 mm (2 each)  
1 long socket, with bi-hex and rubber insert 3/8" **No. 4600**: 16 mm-5/8"  
1 Spark plug socket, long, with hexagon and rubber insert 3/8" **No. 4606**: 18 mm/11/16"  
2 INHEX screwdriver sockets 3/8" **No. 1049**: 7; 9 mm  
1 step-up adaptor 3/8" **No. 409**: 1/4 to 3/8" L. 25 mm  
3 QuickRelease extensions 3/8" **No. 426QR**: L. 75; 160; 240 mm  
1 Wobbel Drive extension 3/8" **No. 427W**: L. 76 mm  
1 QuickRelease universal joint 3/8" **No. 428/1QR**: L. 60 mm  
1 QuickRelease fine-tooth ratchet 3/8" **No. 435QR N**: L. 193 mm  
1 step down adaptor **No. 431**: 3/8 to 1/4"  
1 step-up adaptor **No. 432**: 3/8 to 1/2"  
1 step down adaptor **No. 513**: 1/2 to 3/8"

#### 96830304

6 sockets TORX® 1/2" **No. 50TX**: E12; E14; E16; E18; E20; E24  
20 sockets 1/2" with hex **No. 52**: 10; 11; 12; 13; 14; 15; 16; 17; 18; 19; 20; 21; 22; 23; 24; 26; 27; 28; 30; 32 mm  
7 screwdriver sockets INHEX 1/2" **No. 54**: 6; 7; 8; 10; 12; 14; 17 mm  
7 screwdriver sockets 1/2" **No. 54X**: M5; M6; M8; M10; M12; M14; M16  
8 screwdriver sockets 1/2" **No. 54TX**: T27; T30; T40; T45; T50; T55; T60; T70  
1 Wobble Drive extension 1/2" **No. 509W**: L. 52 mm  
2 QuickRelease socket wrench extensions, with countersunk head 1/2" **No. 503QR**: L. 130; 250 mm  
1 QuickRelease universal joint 1/2" **No. 510QR**: L. 80 mm  
1 Flex handle 1/2" **No. 504-2K**: L. 397 mm  
1 QuickRelease fine-tooth ratchet 1/2" **No. 512QR N**: L. 265.5 mm  
1 telescopic ratchet 1/2" **No. 516**: L. 410 - 630 mm  
3 IMPACT sockets 1/2" **No. 51IMP**: 17; 19; 21 mm

#### 96830305

4 slotted screwdrivers **No. 4622**: 1.0 x 5.5 x 100; 1.2 x 6.5 x 125; 1.6 x 10.0 x 175; 2.0 x 12.0 x 200 mm  
1 DRALL+ cross-head screwdriver **No. 4630**: PH1  
1 DRALL+ cross-head screwdriver **No. 4632**: PH3  
10 TORX® screwdriver **No. 4650**: T6; T7; T8; T9; T10; T15; T20; T25; T27; T30  
1 slotted screwdriver **No. 4724**: 1.0 x 5.5 x 25 mm  
1 PH screwdriver **No. 4734**: PH2  
1 bit ratchet screwdriver 1/4" **No. 4008-1**: L. 250 mm  
1 bit ratchet screwdriver 1/4" **No. 4008-2**: L. 95 mm  
1 bit box No. 1206: 1 bit holder | L. 25 mm: SL4;5;6 mm (2x) | PH1;2;3 (3x) | PZ1;2;3 (3x) | T10;15;20;25;27;30;40 (2x) | T B010;15;20;25;27;30;40 | INHEX 3;4;5 mm | L. 75 mm: SL6 mm | PH2;3 | PZ1;2 | T20;25 | 56 pieces

#### 96830306

2 circlip pliers for internal circlips **No. 6543, 6544**: J2; J21  
2 circlip pliers for external circlips **No. 6545, 6546**: A2; A21  
1 water pump pliers **No. 6572**: L. 240 mm  
1 combination pliers **No. 6700**: L. 180 mm

1 heavy-duty side cutter **No. 6721**: L. 160 mm  
1 telephone pliers **No. 6730**: L. 200 mm  
1 telephone pliers **No. 6731**: L. 200 mm  
5 plastic scrapers **No. 10677-10681**: wide, medium, narrow, angled, pointed blade  
1 work light **No. 13134**: 500, 300, 100 lm  
1 hex L-Key set **No. 10767/9**: 1.5; 2; 2.5; 3; 4; 5; 6; 8; 10 mm  
1 bottle opener STAHLWILLE: L. 135 mm

#### **96830307**

20 combination spanners **No. 13**: 6; 7; 8; 9; 10; 11; 12; 13; 14; 15; 16; 17; 18; 19; 21;  
22; 24; 27; 30; 32 mm  
3 double-ended ring spanners, open-ended **No. 24**: 8 x 10; 11 x 13; 12 x 14 mm  
15 combination ratchet spanners **No. 17**: 8; 9; 10; 11; 12; 13; 14; 15; 16; 17; 18; 19;  
21; 22; 24 mm

#### **96830308**

1 brake caliper brush **No. 12373**: L. 230 mm  
1 telescopic stainless steel mirror **No. 12921M**: L. 178-921 mm  
1 automotive circuit tester **No. 12905**: 6-12 + 24 V  
1 tyre tread caliper **No. 12900/3**: 0-30 mm  
1 caliper **No. 12900**: Measuring range: 150/6 mm/"  
2 magnetic lifters **No. 12600**: 270; 500 g  
1 cable knife **No. 12320**: 111 mm  
1 precision feeler gauge, 13 blades **No. 11095-11097**: 0.05-1 mm  
1 lever bar **No. 11006**: L. 400 mm  
1 gasket scraper **No. 12718**: L. 265 mm  
1 nylon hammer **No. 10956**: 75 Shore  
1 engineer's hammer **No. 10961**: 500 g  
5 pin punches **No. 108**: 3; 4; 5; 6; 8 mm  
1 centre punch **No. 105**: 120 mm  
2 flat chisels **No. 102**: 150; 200 mm  
1 universal self-grip wrench **No. 6563**: L. 250 mm

## **Benefits.**

Heavy-duty, robust tool trolley with 8 fully extendable drawers and central locking, including 349-piece tool set.

Patented QuickRelease locking system secures all components, from the ratchet to the extension to the socket.

The tools are securely integrated in durable, chemical-resistant TCS inlays with precise recesses and colour-coded signal areas.

Extensive automotive range with fine-tooth ratchets, sockets up to 32 mm, measuring and testing tools, screwdrivers, pliers and much more.

The robust 95/8 tool trolley has a static load capacity of up to 750 kg - the bottom drawer has a load capacity of up to 45 kg.

## Product highlights.



PRODUCT IMAGE  
IN PROGRESS

### Complete solution for automotive and industrial applications.

Our comprehensive tool set offers the right solution for professional applications in the automotive and industrial sectors: whether replacing spark plugs, loosening stubborn bolted joints on axle or chassis components, performing electrical testing or maintenance work on machines. It includes fine-tooth ratchets with QuickRelease, sockets in 1/4", 3/8" and 1/2" up to 32 mm, a versatile bit set, long spark plug sockets, precise measuring and testing tools, a wide selection of screwdrivers and pliers, and numerous special tools. This equipment provides a reliable basis for all daily tasks in the workshop and in industrial environments.



### Takes on anything.

High-quality materials such as the tightly welded stainless steel tray with a scratch-resistant honeycomb structure ensure the durability typical of STAHLWILLE and prevent liquids from penetrating into the interior of the trolley. The working surface of 827 x 496 mm is particularly suitable for working on large components. Thanks to its robust construction, the 95 PRO has a static load capacity of 750 kg. Thanks to reinforcements, the drawers can be loaded with 30 kg and the bottom drawer even with 45 kg.



### Full configuration as standard.

Whether paper roll and spray can holders, all-round impact protection with shock absorption, perforations on both sides for attaching accessories, locking brakes or oil and acid-resistant smooth-running castors (Ø 125 mm) with thread protection. Our tool trolley comes with many features as standard.

## Technologies and features.



### Modular Inlay System

This flexible solution for tool storage makes it possible to customize your tool trolleys and workbenches with 1/6, 1/3, 2/3 or 3/3 foam inlays.



### Tool Control System

The intelligent modular inlay system protects and organizes the tools in tool boxes, tool trolleys and workbenches. Two-color foam inlays make checking the completeness of the tools quick and easy.



### QuickRelease

The QuickRelease safety lock prevents unintentional loss of insert tools. These click securely into place, and are only released again at the push of a button for a quick tool change. In transducers: The QuickRelease safety lock helps you to quickly mount and change transducers. The transducers lock into the calibration system and only unlock again at the push of the buttons.



### High Performance Quality (HPQ®)

Our HPQ® tool is made of wear-resistant high-performance steel, yet is thin-walled and lightweight. It withstands high torques and is ideal for work in confined spaces such as turbines.

## Technical drawing.

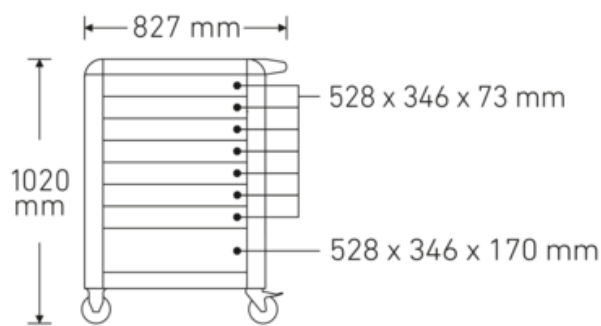
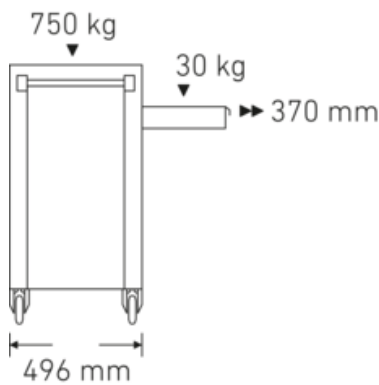

## Technical attributes.

Number of drawers	8
Number of tools	349
Width mm (b)	823 mm
Colour	anthracite, RAL 7016
Height mm (h)	1021 mm
Length mm (L)	497 mm

## Logistics data.

Depth mm (IFS)	800
Width mm (IFS)	600
Height mm (IFS)	1360
WEEE/ElektroG	nicht ear-pflichtig
Length (packaged, mm)	800
Width (packaged, mm)	600
Height (packaging, mm)	1360
Volume (packaged, dm <sup>3</sup> )	652.8 dm <sup>3</sup>
Product no.	98830243
Weight (gross, kg)	120,500
Weight PAP (kg)	7,500
Weight PVC (kg)	0,000
GTIN	4018754363049

Country of origin AWR

GERMANY

Region of origin

Nordrhein-Westfalen

Customs tariff no.

82060000

Packing standard

1

Weight (g)

101000 g

## Parts list.

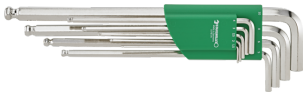

96432600  
Hex ball-ended L-Key set



96080156  
Bit box



77490016  
Work light



77440001  
Steel wire brush



77401032  
Telescopic stainless steel mirror



77380001  
Car circuit tester



77371004  
Tyre-tread Vernier gauge



77371001  
Vernier calliper gauge



77301020  
Bottle opener

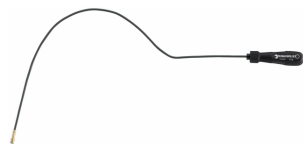

77260027  
Magnetic lifter



77260025  
Magnetic lifter



77020000  
Electricians cable knife



74240001  
Precision feeler gauges



72090002  
Lever bar



72060204  
Plastic scraper



72060203  
Plastic scraper



72060202  
Plastic scraper



72060201  
Plastic scraper



72060200  
Plastic scraper



72033101  
Flat scraper



70171035  
Nylon hammer



70110011  
Engineers hammers



70070006  
Parallel pin punch



70070005  
Parallel pin punch



70070004  
Parallel pin punch



70070003  
Parallel pin punch



70070002  
Parallel pin punch



70050005  
Center punch



70020005  
Cold chisel



70020003  
Cold chisel



67311200  
Telephone pliers



67301200  
Telephone pliers



67211160  
Heavy-duty side cutter



67001180  
Combination pliers



65726240  
Water pump pliers  
FastGRIP



65632250  
Universal self-grip  
wrench



65464121  
Circlip pliers for  
external circlips



65454102  
Circlip pliers for  
external circlips



65444121  
Circlip pliers for  
internal circlips



65434102  
Circlip pliers for  
internal circlips



61019199  
TCS inlay



61019198  
TCS inlay



61019197  
TCS inlay



61019195  
TCS inlay



61018855  
TCS inlay



61018847  
TCS inlay



47341002  
PH cross-head  
screwdriver DRALL®



47241060  
Slotted screwdriver  
DRALL®



46503030  
TORX® screwdriver  
DRALL+



46503027  
TORX® screwdriver  
DRALL+



46503025  
TORX® screwdriver  
DRALL+



46503020  
TORX® screwdriver  
DRALL+



46503015  
TORX® screwdriver  
DRALL+



46503010  
TORX® screwdriver  
DRALL+



46503009  
TORX® screwdriver  
DRALL+



46503008  
TORX® screwdriver  
DRALL+



46503007  
TORX® screwdriver  
DRALL+



46503006  
TORX® screwdriver  
DRALL+



46323303  
PH cross-head  
screwdriver DRALL+



46303001  
PH cross-head  
screwdriver DRALL+



46223565  
Slotted screwdriver  
DRALL+



46223555  
Slotted screwdriver  
DRALL+



46223520  
Slotted screwdriver  
DRALL+



46223500  
Slotted screwdriver  
DRALL+



41172424  
Combination ratchet  
wrench



41172222  
Combination ratchet  
wrench



41172121  
Combination ratchet  
wrench



41171919  
Combination ratchet  
wrench





41171818  
Combination ratchet  
wrench



41171717  
Combination ratchet  
wrench



41171616  
Combination ratchet  
wrench



41171515  
Combination ratchet  
wrench



41171414  
Combination ratchet  
wrench



41171313  
Combination ratchet  
wrench



41171212  
Combination ratchet  
wrench



41171111  
Combination ratchet  
wrench



41171010  
Combination ratchet  
wrench



41170909  
Combination ratchet  
wrench



41170808  
Combination ratchet  
wrench



41081214  
Double-ended open-  
ing wrench, angled



41081113  
Double-ended open-  
ing wrench, angled



41080810  
Double-ended open-  
ing wrench, angled



40083232  
Combination wrench



40083030  
Combination wrench



40082727  
Combination wrench



40082424  
Combination wrench



40082222  
Combination wrench



40082121  
Combination wrench



40081919  
Combination wrench



40081818  
Combination wrench



40081717  
Combination wrench



40081616  
Combination wrench



40081515  
Combination wrench



40081414  
Combination wrench



40081313  
Combination wrench



40081212  
Combination wrench



40081111  
Combination wrench



40081010  
Combination wrench



40080909  
Combination wrench



40080808  
Combination wrench



40080707  
Combination wrench



40080606  
Combination wrench



23021021  
IMPACT wheel nut  
socket



23021019  
IMPACT wheel nut  
socket



23021017  
IMPACT wheel nut  
socket



18120002  
Bit ratchet screwdriver



18120001  
Bit ratchet screwdriver



13160000  
Telescopic ratchet



13111120  
QR fine-tooth ratchet



13061015  
Flexible handle



13030002  
Adapter



13021000  
QuickRelease universal  
joint



13011510  
QR extensions



13011505  
QR extensions



13010005  
Wobble-Drive extension



12111020  
QR fine-tooth ratchet



12030003  
Square drive adaptor



12030001  
Adapter



12021500  
QuickRelease universal joint



12011510  
QR extensions



12011506  
QR extensions



12011503  
QR extensions



12010007  
Wobble-Drive extension



11261010  
QR fine-tooth flexible ratchet



11180010  
Bit holder



11111020  
QR fine-tooth ratchet



11040000  
Flexible extension



11030002  
Square drive adaptor



11021500  
QuickRelease universal joint



11011506  
QR extensions



11011504  
QR extensions



11011502  
QR extensions



11010020  
Extensions w. wobble-drive



03270024  
Socket



03270020  
Socket



03270018  
Socket



03270016  
Socket



03270014  
Socket



03270012  
Socket



03100070  
Screwdriver socket



03100060  
Screwdriver socket



03100055  
Screwdriver socket



03100050  
Screwdriver socket



03100045  
Screwdriver socket



03100040  
Screwdriver socket



03100030  
Screwdriver socket



03100027  
Screwdriver socket



03060016  
Screwdriver socket



03060014  
Screwdriver socket



03060012  
Screwdriver socket



03060010  
Screwdriver socket

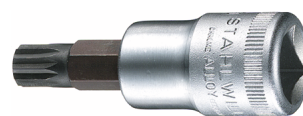

03060008  
Screwdriver socket



03060006  
Screwdriver socket



03060005  
Screwdriver socket



03050017  
INHEX socket



03050014  
INHEX socket



03050012  
INHEX socket



03050010  
INHEX socket



03050008  
INHEX socket

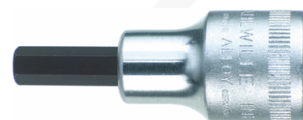

03050007  
INHEX socket



03050006  
INHEX socket



03030032  
Socket



03030030  
Socket



03030028  
Socket



03030027  
Socket



03030026  
Socket



03030024  
Socket



03030023  
Socket



03030022  
Socket



03030021  
Socket



03030020  
Socket



03030019  
Socket



03030018  
Socket



03030017  
Socket



03030016  
Socket



03030015  
Socket



03030014  
Socket



03030013  
Socket



03030012  
Socket



03030011  
Socket



03030010  
Socket



02270014  
Socket



02270012  
Socket



02270010  
Socket



02270008  
Socket



02151009  
INHEX socket

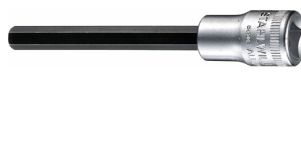

02151007  
INHEX socket



02130018  
Spark plug socket





02050008  
INHEX socket



02050007  
INHEX socket



02050006  
INHEX socket



02020022  
Socket



02020021  
Socket



02020019  
Socket



02020018  
Socket



02020017  
Socket



02020016  
Socket



02020015  
Socket



02020014  
Socket



02020013  
Socket



02020012  
Socket



02020011  
Socket



02020010  
Socket



01351030  
Screwdriver socket



01351027  
Screwdriver socket



01351025  
Screwdriver socket



01351020  
Screwdriver socket



01351015  
Screwdriver socket



01351010  
Screwdriver socket



01351009  
Screwdriver socket



01351008  
Screwdriver socket



01300002  
Screwdriver socket



0130001  
Screwdriver socket



01290002  
Screwdriver socket



01290001  
Screwdriver socket



01270010  
Sockets



01270008  
Sockets



01270007  
Sockets



01270006  
Sockets



01270005  
Sockets



01270004  
Sockets



01140010  
UNIFLEX sockets



01140008  
UNIFLEX sockets



01140006  
UNIFLEX sockets



01050006  
INHEX socket



01050005  
INHEX socket



01050004  
INHEX socket



01050003  
INHEX socket



01020055  
Sockets



01020045  
Sockets



01020013  
Sockets



01020012  
Sockets



01020011  
Sockets



01020010  
Sockets



01020009  
Sockets



01020008  
Sockets



01020007  
Sockets



01020006  
Sockets



01020005  
Sockets



01020004  
Sockets



01010055  
Sockets



01010045  
Sockets



01010014  
Sockets



01010013  
Sockets



01010012  
Sockets



01010011  
Sockets



01010010  
Sockets



01010009  
Sockets



01010008  
Sockets



01010007  
Sockets



01010006  
Sockets



01010005  
Sockets



01010004  
Sockets



81200166  
Tool trolley

## Variants.

Product no.	Model No. (ERP)	Description	GTIN
98830243	95/349QR	Tool set with tool trolley 95/349QR Drawer8 anthracite, RAL 7016 349	4018754363049



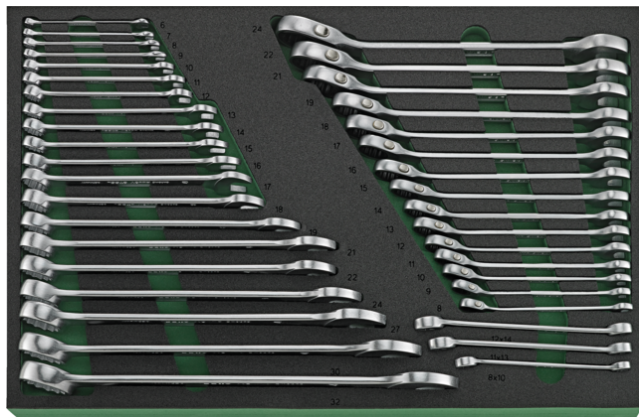

**STAHLWILLE Eduard Wille GmbH**

Lindenallee 27 · 42349 Wuppertal · Germany · Phone: +49 202 4791-0

info@stahlwille.de · www.stahlwille.com

© STAHLWILLE Eduard Wille GmbH, Wuppertal