

IMPACT screwdriver sockets 1/2"

54IMP



Product no. 23050012
GTIN 4018754233847
Model 54 IMP 12



Label. IMPACT screwdriver socket 1/2 " 12 mm L.40mm

Product highlights.



Optimized functionality.

All IMPACT sockets have a through cross hole for the connecting pin and a deep groove for the rubber locking ring. The locking pin is not stressed during use.

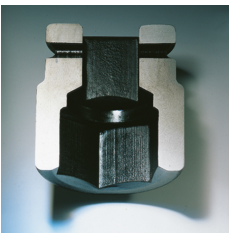

High fitting accuracy.

The high fitting accuracy due to tight tolerances guarantees optimum, backlash-free transmission of forces to the socket.

Technical Drawing.

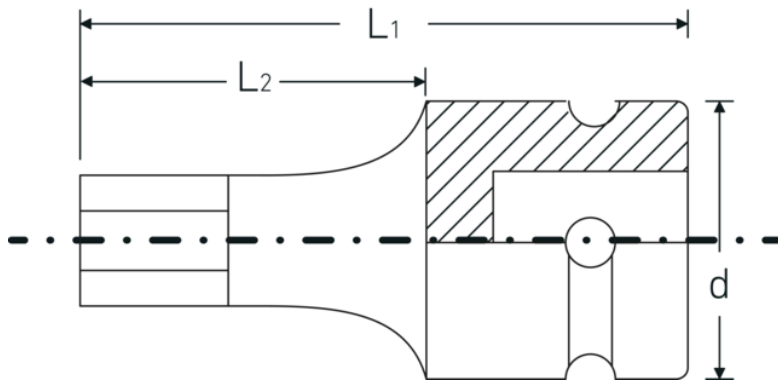

Technical Attributes.

Drive profile	hex
External hex drive (mm)	12 mm
Internal square drive (inch)	1/2 "
d	25 mm
L1	40 mm
L2	20 mm

Logistics data.

Depth mm (IFS)	42
Width mm (IFS)	30
Height mm (IFS)	30
Length (packed, mm)	110
Width (packed, mm)	60
Height (packed, mm)	31
Volume (packed, dm ³)	0.2046 dm ³
Product no.	23050012
Weight (gross, kg)	0,330
Weight PAP (kg)	0,000
Weight PVC (kg)	0,003
GTIN	4018754233847
Country of origin	TAIWAN, PROVINCE OF CHINA
Region of origin	Ausländischer Ursprung
WEEE/ElektroG	nicht ear-pflichtig
Customs tariff no.	82042000
Packing standard	5
Weight	111 g

Variants.

Product no.	Model no. (ERP)	Description	GTIN
23050005	54 IMP 5	IMPACT screwdriver socket 1/2 " 5 mm L.40mm	4018754233793
23050006	54 IMP 6	IMPACT screwdriver socket 1/2 " 6 mm L.40mm	4018754233809

23050007	54 IMP 7	IMPACT screwdriver socket 1/2 " 7 mm L.40mm	4018754233816
23050008	54 IMP 8	IMPACT screwdriver socket 1/2 " 8 mm L.40mm	4018754233823
23050010	54 IMP 10	IMPACT screwdriver socket 1/2 " 10 mm L.40mm	4018754233830
23050012	54 IMP 12	IMPACT screwdriver socket 1/2 " 12 mm L.40mm	4018754233847
23050014	54 IMP 14	IMPACT screwdriver socket 1/2 " 14 mm L.40mm	4018754233854
23050017	54 IMP 17	IMPACT screwdriver socket 1/2 " 17 mm L.40mm	4018754233861
23050019	54 IMP 19	IMPACT screwdriver socket 1/2 " 19 mm L.40mm	4018754233878

GTIN-Code.

