



Ring shell tool

732/10

Product no. 58221019
GTIN 4018754034161
Model 732/10 19



Label.

Ring insertion tool Wrench size 19mm Tool holders 9 x 12

Technical Drawing.

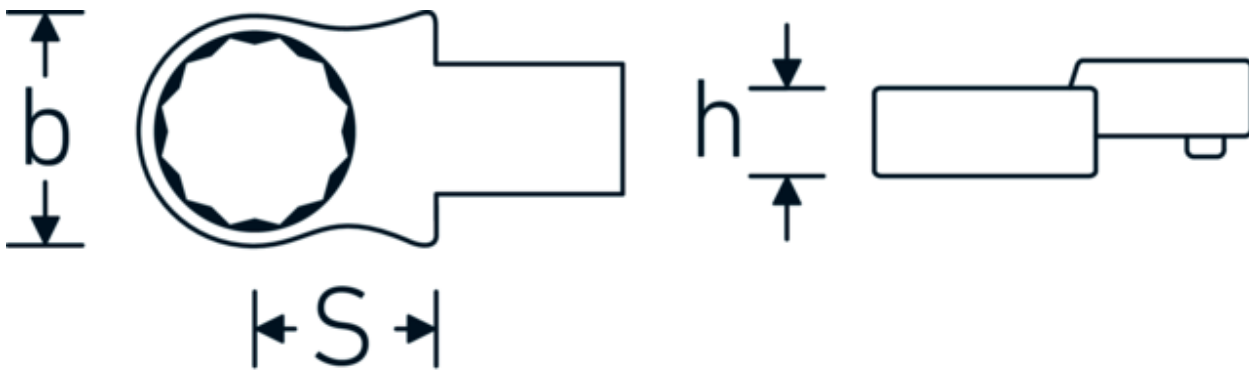

Technical Attributes.

Width mm (b)	30,5 mm
Size square socket [inside square drive]	9 x 12 mm
Height mm (h)	13 mm
S	17,5 mm
Width across flats [mm]	19 mm

Logistics data.

Depth mm (IFS)	50
Width mm (IFS)	31
Height mm (IFS)	15
Length (packed, mm)	56
Width (packed, mm)	34
Height (packed, mm)	16
Volume (packed, dm ³)	0.030464 dm ³
Product no.	58221019
Weight (gross, kg)	0,065

Weight PAP (kg)	0,000
Weight PVC (kg)	0,002
GTIN	4018754034161
Country of origin	GERMANY
Region of origin	Nordrhein-Westfalen
WEEE/ElektroG	nicht ear-pflichtig
Customs tariff no.	82041100
Packing standard	1
Weight	65 g

Variants.

Product no.	Model no. (ERP)	Description	GTIN
58221007	732/10 7	Ring insertion tool Wrench size 7mm Tool holders9 x 12	4018754034055
58221008	732/10 8	Ring insertion tool Wrench size 8mm Tool holders9 x 12	4018754034062
58221010	732/10 10	Ring insertion tool Wrench size 10mm Tool holders9 x 12	4018754034079
58221011	732/10 11	Ring insertion tool Wrench size 11mm Tool holders9 x 12	4018754034086
58221012	732/10 12	Ring insertion tool Wrench size 12mm Tool holders9 x 12	4018754034093
58221013	732/10 13	Ring insertion tool Wrench size 13mm Tool holders9 x 12	4018754034109
58221014	732/10 14	Ring insertion tool Wrench size 14mm Tool holders9 x 12	4018754034116
58221015	732/10 15	Ring insertion tool Wrench size 15mm Tool holders9 x 12	4018754034123
58221016	732/10 16	Ring insertion tool Wrench size 16mm Tool holders9 x 12	4018754034130
58221017	732/10 17	Ring insertion tool Wrench size 17mm Tool holders9 x 12	4018754034147
58221018	732/10 18	Ring insertion tool Wrench size 18mm Tool holders9 x 12	4018754034154
58221019	732/10 19	Ring insertion tool Wrench size 19mm Tool holders9 x 12	4018754034161
58221021	732/10 21	Ring insertion tool Wrench size 21mm Tool holders9 x 12	4018754034178
58221022	732/10 22	Ring insertion tool Wrench size 22mm Tool holders9 x 12	4018754034185

GTIN-Code.

