



IMPACT sockets 1"

60IMP

Product no. **26010027**
GTIN **4018754016259**
Model **60 IMP 27**



Label. IMPACT socket 1 " 27mm L.60mm

Product highlights.



Powerful and resilient.

The sockets are made from high-quality Chrome Alloy Steel. They are hardened in oil to prevent stress and distortion.



Optimized functionality.

All IMPACT sockets have a through cross hole for the connecting pin and a deep groove for the rubber locking ring. The locking pin is not stressed during use.

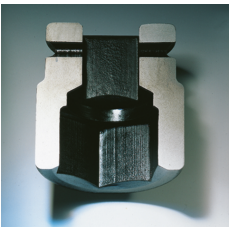

High fitting accuracy.

The high fitting accuracy due to tight tolerances guarantees optimum, backlash-free transmission of forces to the socket.

Technical Drawing.

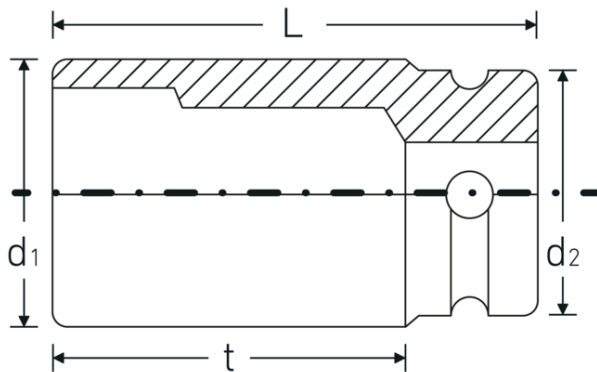

Technical Attributes.

Drive profile	hex
Internal square drive (inch)	1 "
d1	45 mm
d2	54 mm
DIN	DIN 3129 / ISO 1711-2
Length mm (L)	60 mm
Width across flats [mm]	27 mm
t	30 mm

Logistics data.

Depth mm (IFS)	60
Width mm (IFS)	54
Height mm (IFS)	54
Length (packed, mm)	110
Width (packed, mm)	63
Height (packed, mm)	56
Volume (packed, dm3)	0.38808 dm3
Product no.	26010027
Weight (gross, kg)	1,308
Weight PAP (kg)	0,000
Weight PVC (kg)	0,006
GTIN	4018754016259
Country of origin	GERMANY
Region of origin	Nordrhein-Westfalen
WEEE/ElektroG	nicht ear-pflichtig
Customs tariff no.	82042000
Packing standard	2
Weight	654 g

Variants.

Product no.	Model no. (ERP)	Description	GTIN
26010024	60 IMP 24	IMPACT socket 1 " 24mm L.58mm	4018754016242
26010027	60 IMP 27	IMPACT socket 1 " 27mm L.60mm	4018754016259
26010030	60 IMP 30	IMPACT socket 1 " 30mm L.62mm	4018754016266

26010032	60 IMP 32	IMPACT socket 1 " 32mm L.63mm	4018754016273
26010033	60 IMP 33	IMPACT socket 1 " 33mm L.63mm	4018754016280
26010036	60 IMP 36	IMPACT socket 1 " 36mm L.67mm	4018754016303
26010038	60 IMP 38	IMPACT socket 1 " 38mm L.70mm	4018754016327
26010041	60 IMP 41	IMPACT socket 1 " 41mm L.70mm	4018754016334
26010042	60 IMP 42	IMPACT socket 1 " 42mm L.73mm	4018754016341
26010046	60 IMP 46	IMPACT socket 1 " 46mm L.76mm	4018754016358
26010050	60 IMP 50	IMPACT socket 1 " 50mm L.82mm	4018754016365
26010055	60 IMP 55	IMPACT socket 1 " 55mm L.87mm	4018754016372
26010060	60 IMP 60	IMPACT socket 1 " 60mm L.91mm	4018754016396
26010065	60 IMP 65	IMPACT socket 1 " 65mm L.80mm	4018754233991
26010070	60 IMP 70	IMPACT socket 1 " 70mm L.85mm	4018754234004
26010075	60 IMP 75	IMPACT socket 1 " 75mm L.95mm	4018754234011
26010080	60 IMP 80	IMPACT socket 1 " 80mm L.100mm	4018754234028

GTIN-Code.

