



## Ring shell tool

**732/40**

Product no. **58224022**  
GTIN **4018754034277**  
Model **732/40 22**



### Label.

Ring insertion tool Wrench size 22mm Tool holders 14 x 18

### Technical Drawing.

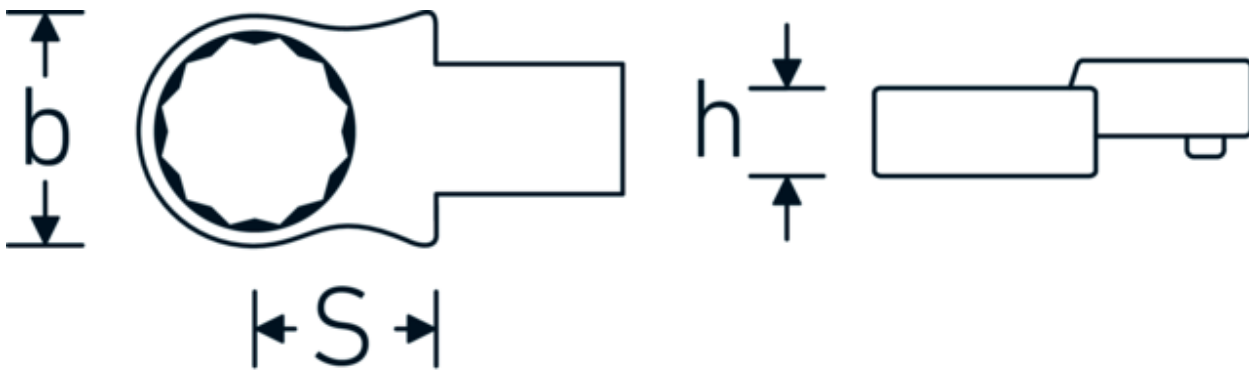

### Technical Attributes.

Width mm (b)	34,5 mm
Size square socket [inside square drive]	14 x 18 mm
Height mm (h)	15 mm
S	25 mm
Width across flats [mm]	22 mm

### Logistics data.

Depth mm (IFS)	68
Width mm (IFS)	35
Height mm (IFS)	21
Length (packed, mm)	74
Width (packed, mm)	38
Height (packed, mm)	22
Volume (packed, dm <sup>3</sup> )	0.061864 dm <sup>3</sup>
Product no.	58224022
Weight (gross, kg)	0,148

<b>Weight PAP (kg)</b>	0,000
<b>Weight PVC (kg)</b>	0,002
<b>GTIN</b>	4018754034277
<b>Country of origin</b>	GERMANY
<b>Region of origin</b>	Nordrhein-Westfalen
<b>WEEE/ElektroG</b>	nicht ear-pflichtig
<b>Customs tariff no.</b>	82041100
<b>Packing standard</b>	1
<b>Weight</b>	145 g

## Variants.

Product no.	Model no. (ERP)	Description	GTIN
58224013	732/40 13	Ring insertion tool Wrench size 13mm Tool holders14 x 18	4018754034192
58224014	732/40 14	Ring insertion tool Wrench size 14mm Tool holders14 x 18	4018754034208
58224015	732/40 15	Ring insertion tool Wrench size 15mm Tool holders14 x 18	4018754034215
58224016	732/40 16	Ring insertion tool Wrench size 16mm Tool holders14 x 18	4018754034222
58224017	732/40 17	Ring insertion tool Wrench size 17mm Tool holders14 x 18	4018754034239
58224018	732/40 18	Ring insertion tool Wrench size 18mm Tool holders14 x 18	4018754034246
58224019	732/40 19	Ring insertion tool Wrench size 19mm Tool holders14 x 18	4018754034253
58224021	732/40 21	Ring insertion tool Wrench size 21mm Tool holders14 x 18	4018754034260
58224022	732/40 22	Ring insertion tool Wrench size 22mm Tool holders14 x 18	4018754034277
58224024	732/40 24	Ring insertion tool Wrench size 24mm Tool holders14 x 18	4018754034284
58224027	732/40 27	Ring insertion tool Wrench size 27mm Tool holders14 x 18	4018754034291
58224028	732/40 28	Ring insertion tool Wrench size 28mm Tool holders14 x 18	4018754162307
58224030	732/40 30	Ring insertion tool Wrench size 30mm Tool holders14 x 18	4018754034307
58224032	732/40 32	Ring insertion tool Wrench size 32mm Tool holders14 x 18	4018754034314
58224034	732/40 34	Ring insertion tool Wrench size 34mm Tool holders14 x 18	4018754034321

58224036	732/40 36	Ring insertion tool Wrench size 36mm Tool holders14 x 18	4018754034338
58224041	732/40 41	Ring insertion tool Wrench size 41mm Tool holders14 x 18	4018754034345

## GTIN-Code.

