



Electronic workshop tester SENSOTORK®

7707 W

Product no. **96521084**
GTIN **4018754181179**
Model **7707-2-2W**



Label.

Electronic workshop tester SENSOTORK® Measuring r.8-400N·m Internal square 3/4"

Features.

- for testing indicating and triggering torque screwdrivers
- compact electronic testing device consisting of:
 - 1 patented transducer
 - 1 safety lock
 - 1 display device (DBGM)
 - 1 stand with 1.5 metre cable for the display unit
 - 1 spiral cable
 - 1 power supply (110 V-230 with interchangeable plug adapters)
 - 4 interchangeable square drive adapters for the square drive
- large LCD display for optimum readability
- horizontal or vertical installations
- for controlled right and left measuring
- 3 operating modes: running display of the applied torque (Track), display of the torque on triggering/kink point detection (First-Peak), peak value display (Peak-Hold)
- additional control from the display of the actual tightened torque on triggering torque wrenches
- with QuickRelease security lock
- low transverse forces due to flat transducers
- automatic detection of transducers
- particularly large measurement range from about 2% to 100% of the nominal value
- 3 measuring units (N·m, ft·lb, in·lb)
- software No. 7759-4, including USB adapter and jack cable, allows the measured values to be transmitted to a PC (no additional external power source, power from the PC)
- when recalibrating the individual transducers, the test equipment remains operational on site
- complies with the specifications of guideline DKD-R 10-8
- with certificate
- delivered in a sturdy plastic box

Advantages.

Electronic workshop tester for checking and adjusting indicating and triggering torque wrenches.

Simple, quick and reliable testing of torque wrenches to ensure quality in production.

Measurement in the large torque range up to 1.100 N·m.

Simple exchange of transducers enables quick adjustment to different measuring tasks and specific testing requirements.

The interchangeable square adapters in the mounting block allow flexible use with standard square drive sizes.



Product highlights.



PRODUCT IMAGE
IN PROGRESS

Flexible mounting.

Whether mounted horizontally or vertically - the well-designed mounting points, compact design and rotatable display allow flexible positioning anywhere in the workshop.



PRODUCT IMAGE
IN PROGRESS

Customised drive solution.

Up to 4 square adapters are integrated into the mounting block of the device, within easy reach, to enable flexible use with standard square drive sizes.



PRODUCT IMAGE
IN PROGRESS

Adaptive measuring system.

Our SENSOTORK® 7707W features easily interchangeable transducers. This gives it the ability to be customised for individual measurement requirements.



PRODUCT IMAGE
IN PROGRESS

Resistance to transverse forces.

The high level of accuracy is achieved by flat transducers and a special technology for immediate data processing directly in the transducer. Thanks to an integrated measurement amplifier, the testing device is resistant to bending moments and transverse forces.

Technologies and features.



QuickRelease

Technical Drawing.

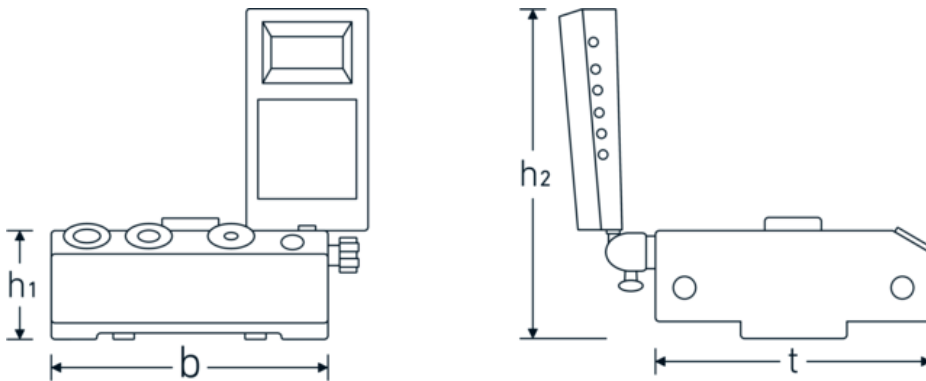

Technical Attributes.

Measuring range N·m	8-400 N·m
Internal square [inch]	3/4 "
Width mm (b)	180 mm
Weight with box	11100 g
Height mm (h)	165 mm
Height mm (h1)	79 mm
Height mm (h2)	215 mm
Model no.	7707-2-2W
t	180 mm

Logistics data.

Depth mm (IFS)	440
Width mm (IFS)	340
Height mm (IFS)	165
Length (packed, mm)	440
Width (packed, mm)	340
Height (packed, mm)	165
Volume (packed, dm ³)	24.684 dm ³
Art. no.	96521084
Weight (gross, kg)	10,700
Weight PAP (kg)	0,016
Weight PVC (kg)	0,000
GTIN	4018754181179
Country of origin	GERMANY
Region of origin	Nordrhein-Westfalen
WEEE/ElektroG	Kleingeräte B2C
Customs tariff no.	90318080
Packing standard	1
Weight	7654 g

Variants.

Art. no.	Model no. (ERP)	Description	GTIN
96521086	7707-1-3W	Electronic workshop tester SENSOTORK® Measuring r.0,2-10N·m Internal square 1/4"	4018754241958
96521085	7707-1-2W	Electronic workshop tester SENSOTORK® Measuring r.0,2-10N·m Internal square 1/4"	4018754241941
96521080	7707N-1W	Electronic workshop tester SENSOTORK® Measuring r.0,4-20N·m Internal square 1/4"	4018754181148
96521072	7707-2W	Electronic workshop tester SENSOTORK® Measuring r.2-100N·m Internal square 3/8"	4018754155781
96521083	7707-2-1W	Electronic workshop tester SENSOTORK® Measuring r.4-200N·m Internal square 1/2"	4018754181162
96521084	7707-2-2W	Electronic workshop tester SENSOTORK® Measuring r.8-400N·m Internal square 3/4"	4018754181179
96521082	7707N-3W	Electronic workshop tester SENSOTORK® Measuring r.25-1100N·m Internal square 3/4"	4018754181155

GTIN-Code.



STAHLWILLE Eduard Wille GmbH & Co. KG

Lindenallee 27 · 42349 Wuppertal · Germany · Phone: +49 202 4791-0 · Fax: +49 202 4791-200
 info@stahlwille.de · www.stahlwille.com · Copyright by STAHLWILLE Eduard Wille GmbH & Co. KG, Wuppertal
 Copyright by STAHLWILLE Eduard Wille GmbH & Co. KG, Wuppertal