



IMPACT sockets 1"

60IMP

Product no. **26010033**
GTIN **4018754016280**
Model **60 IMP 33**



Label. IMPACT socket 1 " 33mm L.63mm

Product highlights.



Powerful and resilient.

The sockets are made from high-quality Chrome Alloy Steel. They are hardened in oil to prevent stress and distortion.



Optimized functionality.

All IMPACT sockets have a through cross hole for the connecting pin and a deep groove for the rubber locking ring. The locking pin is not stressed during use.



High fitting accuracy.

The high fitting accuracy due to tight tolerances guarantees optimum, backlash-free transmission of forces to the socket.

Technical Drawing.

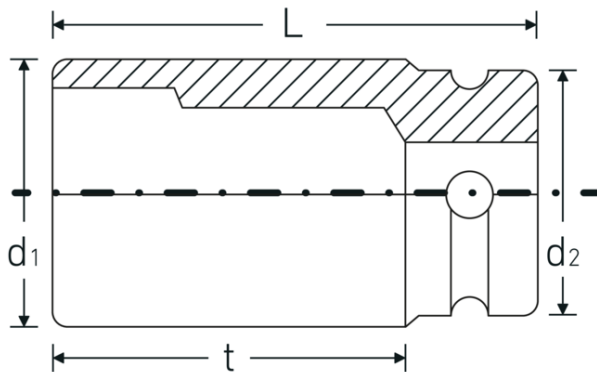

Technical Attributes.

Drive profile	hex
Internal square drive (inch)	1 "
d1	52,5 mm
d2	54 mm
DIN	DIN 3129 / ISO 1711-2
Length mm (L)	63 mm
Width across flats [mm]	33 mm
t	31,5 mm

Logistics data.

Depth mm (IFS)	63
Width mm (IFS)	54
Height mm (IFS)	54
Length (packed, mm)	115
Width (packed, mm)	66
Height (packed, mm)	56
Volume (packed, dm ³)	0.42504 dm ³
Product no.	26010033
Weight (gross, kg)	1,384
Weight PAP (kg)	0,000
Weight PVC (kg)	0,007
GTIN	4018754016280
Country of origin	GERMANY
Region of origin	Nordrhein-Westfalen
WEEE/ElektroG	nicht ear-pflichtig
Customs tariff no.	82042000
Packing standard	2
Weight	695 g

Variants.

Product no.	Model no. (ERP)	Description	GTIN
26010024	60 IMP 24	IMPACT socket 1 " 24mm L.58mm	4018754016242
26010027	60 IMP 27	IMPACT socket 1 " 27mm L.60mm	4018754016259
26010030	60 IMP 30	IMPACT socket 1 " 30mm L.62mm	4018754016266

26010032	60 IMP 32	IMPACT socket 1 " 32mm L.63mm	4018754016273
26010033	60 IMP 33	IMPACT socket 1 " 33mm L.63mm	4018754016280
26010036	60 IMP 36	IMPACT socket 1 " 36mm L.67mm	4018754016303
26010038	60 IMP 38	IMPACT socket 1 " 38mm L.70mm	4018754016327
26010041	60 IMP 41	IMPACT socket 1 " 41mm L.70mm	4018754016334
26010042	60 IMP 42	IMPACT socket 1 " 42mm L.73mm	4018754016341
26010046	60 IMP 46	IMPACT socket 1 " 46mm L.76mm	4018754016358
26010050	60 IMP 50	IMPACT socket 1 " 50mm L.82mm	4018754016365
26010055	60 IMP 55	IMPACT socket 1 " 55mm L.87mm	4018754016372
26010060	60 IMP 60	IMPACT socket 1 " 60mm L.91mm	4018754016396
26010065	60 IMP 65	IMPACT socket 1 " 65mm L.80mm	4018754233991
26010070	60 IMP 70	IMPACT socket 1 " 70mm L.85mm	4018754234004
26010075	60 IMP 75	IMPACT socket 1 " 75mm L.95mm	4018754234011
26010080	60 IMP 80	IMPACT socket 1 " 80mm L.100mm	4018754234028

GTIN-Code.

