



Ring shell tool

732/40

Product no. **58224041**
GTIN **4018754034345**
Model **732/40 41**



Label.

Ring insertion tool Wrench size 41mm Tool holders 14 x 18

Technical Drawing.

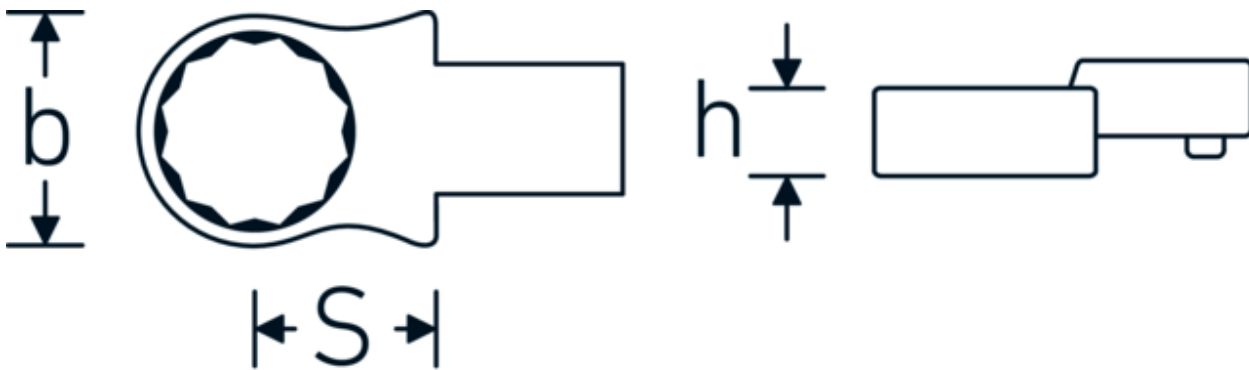

Technical Attributes.

Width mm (b)	60 mm
Size square socket [inside square drive]	14 x 18 mm
Height mm (h)	20 mm
S	30 mm
Width across flats [mm]	41 mm

Logistics data.

Depth mm (IFS)	85
Width mm (IFS)	59
Height mm (IFS)	22
Length (packed, mm)	91
Width (packed, mm)	62
Height (packed, mm)	23
Volume (packed, dm ³)	0.129766 dm ³
Product no.	58224041
Weight (gross, kg)	0,246

Weight PAP (kg)	0,000
Weight PVC (kg)	0,003
GTIN	4018754034345
Country of origin	GERMANY
Region of origin	Nordrhein-Westfalen
WEEE/ElektroG	nicht ear-pflichtig
Customs tariff no.	82041100
Packing standard	1
Weight	240 g

Variants.

Product no.	Model no. (ERP)	Description	GTIN
58224013	732/40 13	Ring insertion tool Wrench size 13mm Tool holders14 x 18	4018754034192
58224014	732/40 14	Ring insertion tool Wrench size 14mm Tool holders14 x 18	4018754034208
58224015	732/40 15	Ring insertion tool Wrench size 15mm Tool holders14 x 18	4018754034215
58224016	732/40 16	Ring insertion tool Wrench size 16mm Tool holders14 x 18	4018754034222
58224017	732/40 17	Ring insertion tool Wrench size 17mm Tool holders14 x 18	4018754034239
58224018	732/40 18	Ring insertion tool Wrench size 18mm Tool holders14 x 18	4018754034246
58224019	732/40 19	Ring insertion tool Wrench size 19mm Tool holders14 x 18	4018754034253
58224021	732/40 21	Ring insertion tool Wrench size 21mm Tool holders14 x 18	4018754034260
58224022	732/40 22	Ring insertion tool Wrench size 22mm Tool holders14 x 18	4018754034277
58224024	732/40 24	Ring insertion tool Wrench size 24mm Tool holders14 x 18	4018754034284
58224027	732/40 27	Ring insertion tool Wrench size 27mm Tool holders14 x 18	4018754034291
58224028	732/40 28	Ring insertion tool Wrench size 28mm Tool holders14 x 18	4018754162307
58224030	732/40 30	Ring insertion tool Wrench size 30mm Tool holders14 x 18	4018754034307
58224032	732/40 32	Ring insertion tool Wrench size 32mm Tool holders14 x 18	4018754034314
58224034	732/40 34	Ring insertion tool Wrench size 34mm Tool holders14 x 18	4018754034321

58224036	732/40 36	Ring insertion tool Wrench size 36mm Tool holders 14 x 18	4018754034338
58224041	732/40 41	Ring insertion tool Wrench size 41mm Tool holders 14 x 18	4018754034345

GTIN-Code.

