



Separation assembly

11500

Product no. **71050018**
GTIN **4018754342242**
Model **11500/3 Trennvorrichtung zu
Abziehvorr.**

Label.

Disconnecter

Product highlights.

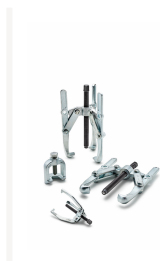

Technical Drawing.

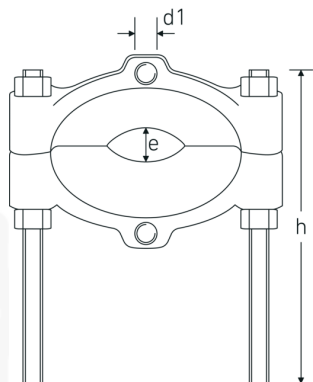

Technical Attributes.

for threads	M14 x 1,5
for model	11501/3
Size	3
Height mm (h)	0 mm
Spreading range (min./max.) mm	22-115 mm

Logistics data.

Depth mm (IFS)	212
Width mm (IFS)	165
Height mm (IFS)	28
Length (packed, mm)	248
Width (packed, mm)	170
Height (packed, mm)	33
Volume (packed, dm3)	1.39128 dm3
Product no.	71050018
Weight (gross, kg)	2,292
Weight PAP (kg)	0,056
Weight PVC (kg)	0,000
GTIN	4018754342242
Country of origin	GERMANY
Region of origin	Nordrhein-Westfalen
WEEE/ElektroG	nicht ear-pflichtig
Customs tariff no.	82055980
Packing standard	1
Weight	2400 g

Variants.

Product no.	Model no. (ERP)	Description	GTIN
71050016	11500/1 Trennvorrichtung zu Abziehvorr.	Disconnecter	4018754342228
71050017	11500/2 Trennvorrichtung zu Abziehvorr.	Disconnecter	4018754342235
71050018	11500/3 Trennvorrichtung zu Abziehvorr.	Disconnecter	4018754342242
71050019	11500/4 Trennvorrichtung zu Abziehvorr.	Disconnecter	4018754342259

GTIN-Code.



Accessories.



71050103
Puller

Images.

