

Spline-drive adapters

447aSP



Artikelnr. **02480016**
GTIN **4018754134762**
Model **447A SP 8 = 1/4**



Aanwijzing.

Adapter 1/4" Binnenkant vierkant 3/8"

Eigenschappen.

- MS-33787, MIL-W-8982
- HPQ®-High performance staal, gebruieneerd
- Opgelet! Veranderde instelwaarden van de momentsleutel <!-- (zie instructie pag. [170524]) -->

Voordelen.

voor buitenschroeven met spline-drive

Technologieën en kenmerken.



Technische tekening.

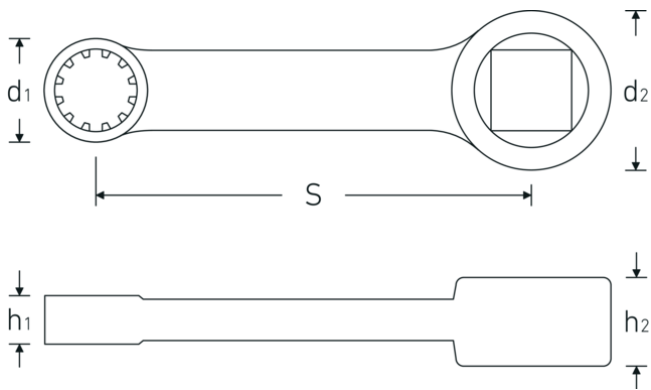

Technische kenmerken.

Vierkant [inch]	3/8 "
d1	10,4 mm
d2	19 mm
Hoogte mm (h1)	6 mm
Hoogte mm (h2)	11 mm
S	50,8 mm
Breedte over vlakken [inch]	1/4 "

Logistieke gegevens.

Diepte mm (IFS)	61
Breedte mm (IFS)	15
Hoogte mm (IFS)	7
Lengte (verpakt, mm)	71
Breedte (verpakt, mm)	25
Hoogte (verpakt, mm)	9
Volume (verpakt, dm ³)	0.015975 dm ³
Artikelnr.	02480016
Gewicht (bruto, KG)	0,031
Gewicht PAP (KG)	0,000
Gewicht PVC (KG)	0,002
GTIN	4018754134762
Land van oorsprong	GERMANY
Regio van oorsprong	Nordrhein-Westfalen
WEEE/ElektroG	nicht ear-pflichtig
Douanetarief nr.	82042000
Verpakkingsstandaard	1
Gewicht (g)	27 g

Varianten.

Artikelnr.	Modelnr. (ERP)	Beschrijving	GTIN
02480014	447A SP 7 = 7/32	Adapter 7/32" Binnenkant vierkant 3/8"	4018754134755
02480016	447A SP 8 = 1/4	Adapter 1/4" Binnenkant vierkant 3/8"	4018754134762
02480018	447A SP 9 = 9/32	Adapter 9/32" Binnenkant vierkant 3/8"	4018754133215

02480020	447A SP 10 = 5/16	Adapter 5/16" Binnenkant vierkant 3/8"	4018754133222
02480024	447A SP 12 = 3/8	Adapter 3/8" Binnenkant vierkant 3/8"	4018754133239
02480028	447A SP 14 = 7/16	Adapter 7/16" Binnenkant vierkant 3/8"	4018754133246
02480032	447A SP 16 = 1/2	Adapter 1/2" Binnenkant vierkant 3/8"	4018754134779
02480034	447A SP 18 = 9/16	Adapter 9/16" Binnenkant vierkant 3/8"	4018754134786
02480036	447A SP 20 = 5/8	Adapter 5/8" Binnenkant vierkant 3/8"	4018754136445

GTIN-code.

