

**Adjustable open-ended wrench,  
metric**

**4025**



Product no. **40250108**  
GTIN **4018754299515**  
Model **4025 8**

**Label.** Adjustable open-ended wrench max. wrench size 30mm L.207mm

**Technical Drawing.**

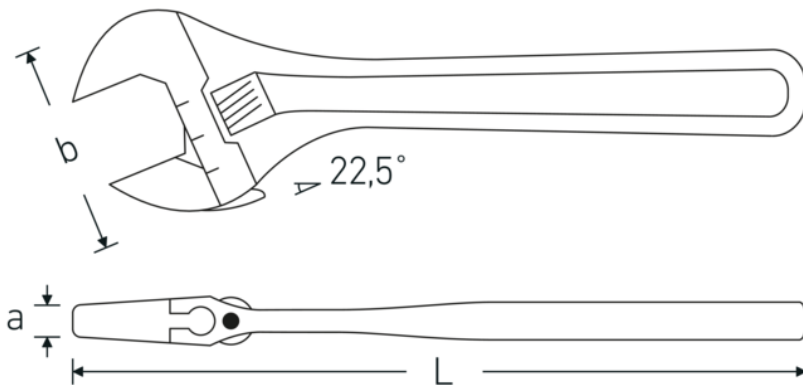

**Technical Attributes.**

<b>a</b>	14 mm
<b>Width mm (b)</b>	62 mm
<b>DIN</b>	DIN 3117 / ISO 6787 Form B
<b>Size</b>	8
<b>Length mm (L)</b>	207 mm
<b>Schlüsselweite max. [mm]</b>	30 mm

**Logistics data.**

<b>Depth mm (IFS)</b>	205
<b>Width mm (IFS)</b>	58
<b>Height mm (IFS)</b>	13
<b>Length (packed, mm)</b>	210
<b>Width (packed, mm)</b>	60
<b>Height (packed, mm)</b>	60
<b>Volume (packed, dm3)</b>	0.756 dm3
<b>Product no.</b>	40250108
<b>Weight (gross, kg)</b>	1,330

<b>Weight PAP (kg)</b>	0,000
<b>Weight PVC (kg)</b>	0,010
<b>GTIN</b>	4018754299515
<b>Country of origin</b>	SPAIN
<b>Region of origin</b>	Ausländischer Ursprung
<b>WEEE/ElektroG</b>	nicht ear-pflichtig
<b>Customs tariff no.</b>	82041200
<b>Packing standard</b>	5
<b>Weight</b>	310 g

## Variants.

Product no.	Art. no. (ERP)	Description	GTIN
40250104	4025 4	Adjustable open-ended wrench max. wrench size 13mm L.115mm	4018754299492
40250106	4025 6	Adjustable open-ended wrench max. wrench size 24mm L.161mm	4018754299508
40250108	4025 8	Adjustable open-ended wrench max. wrench size 30mm L.207mm	4018754299515
40250110	4025 10	Adjustable open-ended wrench max. wrench size 34mm L.259mm	4018754299522
40250112	4025 12	Adjustable open-ended wrench max. wrench size 39mm L.311mm	4018754299539
40250115	4025 15	Adjustable open-ended wrench max. wrench size 44mm L.386mm	4018754299546
40250118	4025 18	Adjustable open-ended wrench max. wrench size 53mm L.462mm	4018754299553

## GTIN-Code.

