

Adapter

447



Product no. **02181007**
GTIN **4018754139125**
Model **447 7**



Label. Adapter 7mm Internal square 3/8"

- Features.**
- HPQ® heavy-duty steel, gun metal finish
 - Please note: Changed setting values on the torque wrench

Technical Drawing.

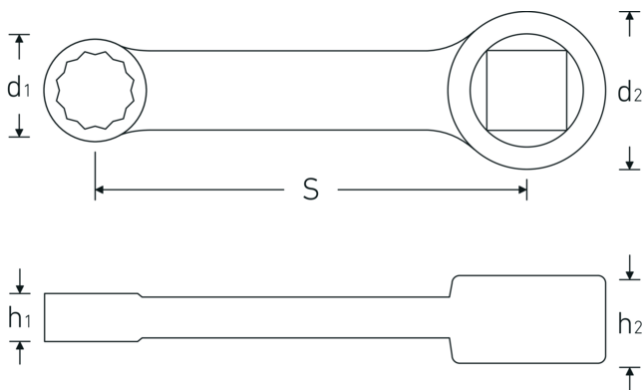

Technical Attributes.

Internal square [inch]	3/8 "
d1	11,5 mm
d2	19 mm
Height mm (h1)	6 mm
Height mm (h2)	11 mm
S	50,8 mm
Width across flats [mm]	7 mm

Logistics data.

Depth mm (IFS)	65
Width mm (IFS)	18
Height mm (IFS)	10
Length (packed, mm)	110
Width (packed, mm)	30
Height (packed, mm)	15
Volume (packed, dm3)	0.0495 dm3

Art. no.	02181007
Weight (gross, kg)	0,035
Weight PAP (kg)	0,000
Weight PVC (kg)	0,002
GTIN	4018754139125
Country of origin	GERMANY
Region of origin	Nordrhein-Westfalen
WEEE/ElektroG	nicht ear-pflichtig
Customs tariff no.	82042000
Packing standard	1
Weight	30 g

Variants.

Art. no.	Model no. (ERP)	Description	GTIN
02181007	447 7	Adapter 7mm Internal square 3/8"	4018754139125
02181008	447 8	Adapter 8mm Internal square 3/8"	4018754139132
02181009	447 9	Adapter 9mm Internal square 3/8"	4018754140992
02181010	447 10	Adapter 10mm Internal square 3/8"	4018754141005
02181013	447 13	Adapter 13mm Internal square 3/8"	4018754141012

GTIN-Code.



STAHLWILLE Eduard Wille GmbH & Co. KG

Lindenallee 27 · 42349 Wuppertal · Germany · Phone: +49 202 4791-0 · Fax: +49 202 4791-200
 info@stahlwille.de · www.stahlwille.com · Copyright by STAHLWILLE Eduard Wille GmbH & Co. KG, Wuppertal
 Copyright by STAHLWILLE Eduard Wille GmbH & Co. KG, Wuppertal