

Adapters

447



Artikelnr. **02181007**
GTIN **4018754139125**
Model **447 7**



Aanwijzing.

Adapter 7mm Binnenkant vierkant 3/8"

Eigenschappen.

- HPQ®-high performance staal, gebruineerd
- Opgelet! Veranderde instelwaarden van de momentsleutel <!-- (zie instructie pag. [170524]) -->

Technische tekening.

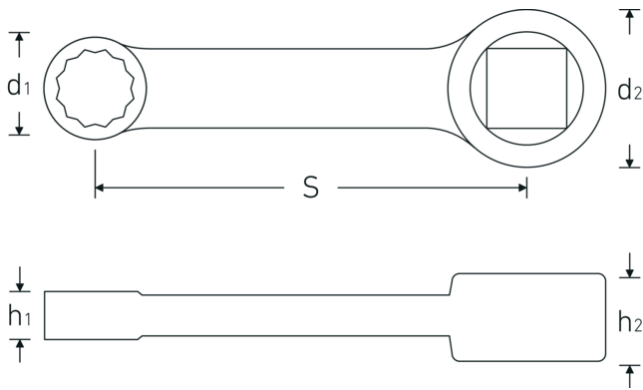

Technische kenmerken.

Vierkant [inch]	3/8 "
d1	11,5 mm
d2	19 mm
Hoogte mm (h1)	6 mm
Hoogte mm (h2)	11 mm
S	50,8 mm

Logistieke gegevens.

Diepte mm (IFS)	65
Breedte mm (IFS)	18
Hoogte mm (IFS)	10
Lengte (verpakt, mm)	110
Breedte (verpakt, mm)	30
Hoogte (verpakt, mm)	15

Sleutelplaatdikte [mm]	7 mm	Volume (verpakt, dm3)	0.0495 dm3
		Artikelnr.	02181007
		Gewicht (bruto, KG)	0,035
		Gewicht PAP (KG)	0,000
		Gewicht PVC (KG)	0,002
		GTIN	4018754139125
		Land van oorsprong	GERMANY
		Regio van oorsprong	Nordrhein-Westfalen
		WEEE/ElektroG	nicht ear-pflichtig
		Douanetarief nr.	82042000
		Verpakkingsstandaard	1
		Gewicht (g)	30 g

Varianten.

Artikelnr.	Modelnr. (ERP)	Beschrijving	GTIN
02181007	447 7	Adapter 7mm Binnenkant vierkant 3/8"	4018754139125
02181008	447 8	Adapter 8mm Binnenkant vierkant 3/8"	4018754139132
02181009	447 9	Adapter 9mm Binnenkant vierkant 3/8"	4018754140992
02181010	447 10	Adapter 10mm Binnenkant vierkant 3/8"	4018754141005
02181013	447 13	Adapter 13mm Binnenkant vierkant 3/8"	4018754141012

GTIN-code.

