



## Verstelbare moersleutel, metrisch

4026N



Artikelnr. 40260112  
GTIN 4018754299607  
Model 4026 12

### Aanwijzing.

Verstelbare moersleutel max.m. 39mm L.311mm

### Eigenschappen.

- rechtsdraaiend
- DIN 3117/ISO 6787 model B
- ASME B 107.100
- bekstand 22,5°
- Chroom-Vanadium, gefosfateerd

### Voordelen.

linksdraaiend

### Technische tekening.

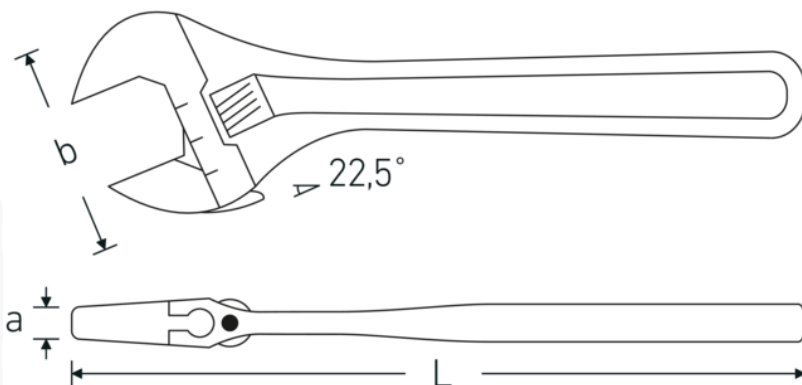

## Technische kenmerken.

<b>a</b>	19 mm
<b>Breedte mm (b)</b>	84 mm
<b>DIN</b>	DIN 3117 / ISO 6787 Form B
<b>M.</b>	12
<b>Lengte mm (L)</b>	311 mm
<b>Schlüsselweite max. [mm]</b>	39 mm

## Logistieke gegevens.

<b>Diepte mm (IFS)</b>	310
<b>Breedte mm (IFS)</b>	80
<b>Hoogte mm (IFS)</b>	18
<b>Lengte (verpakt, mm)</b>	312
<b>Breedte (verpakt, mm)</b>	110
<b>Hoogte (verpakt, mm)</b>	54
<b>Volume (verpakt, dm3)</b>	1.85328 dm3
<b>Artikelnr.</b>	40260112
<b>Gewicht (bruto, CG)</b>	3,495
<b>Gewicht PAP (CG)</b>	0,000
<b>Gewicht PVC (CG)</b>	0,016
<b>GTIN</b>	4018754299607
<b>Land van oorsprong</b>	SPAIN
<b>Regio van oorsprong</b>	Ausländischer Ursprung
<b>WEEE/ElektroG</b>	nicht ear-pflichtig
<b>Douanetarief nr.</b>	82041200
<b>Verpakkingsstandaard</b>	5
<b>Gewicht (g)</b>	805 g

## Varianten.

Artikelnr.	Artikelnr. (ERP)	Beschrijving	GTIN
40260104	4026 4	Verstelbare moersleutel max.m. 13mm L.115mm	4018754299560
40260106	4026 6	Verstelbare moersleutel max.m. 24mm L.161mm	4018754299577
40260108	4026 8	Verstelbare moersleutel max.m. 30mm L.207mm	4018754299584
40260110	4026 10	Verstelbare moersleutel max.m. 34mm L.259mm	4018754299591
40260112	4026 12	Verstelbare moersleutel max.m. 39mm L.311mm	4018754299607
40260115	4026 15	Verstelbare moersleutel max.m. 44mm L.386mm	4018754299614
40260118	4026 18	Verstelbare moersleutel max.m. 53mm L.462mm	4018754299621

## GTIN-code.

