



Adjustable open-ended spanner, metric

4026N



Product no. **40260108**
GTIN **4018754299584**
Model **4026 8**

Label. Adjustable open-ended spanner max. spanner size 30mm L.207mm

- Features.**
- left-handed
 - DIN 3117/ISO 6787 (B shape)
 - ASME B 107.100
 - jaw offset 22.5°
 - Chrome-Vanadium, gunmetal finish

Advantages.

Left-handed

Technical Drawing.

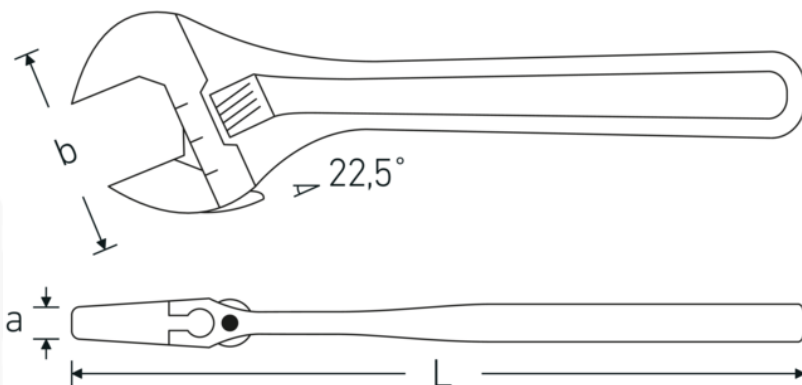

Technical Attributes.

a	14 mm
Width mm (b)	62 mm
DIN	DIN 3117 / ISO 6787 Form B
Size	8
Length mm (L)	207 mm
Schlüsselweite max. [mm]	30 mm

Logistics data.

Depth mm (IFS)	206
Width mm (IFS)	57
Height mm (IFS)	13
Length (packed, mm)	213
Width (packed, mm)	67
Height (packed, mm)	50
Volume (packed, dm3)	0.71355 dm3
Art. no.	40260108
Weight (gross, kg)	1,235
Weight PAP (kg)	0,000
Weight PVC (kg)	0,010
GTIN	4018754299584
Country of origin	SPAIN
Region of origin	Ausländischer Ursprung
WEEE/ElektroG	nicht ear-pflichtig
Customs tariff no.	82041200
Packing standard	5
Weight	310 g

Variants.

Art. no.	Art. no. (ERP)	Description	GTIN
40260104	4026 4	Adjustable open-ended spanner max. spanner size 13mm L.115mm	4018754299560
40260106	4026 6	Adjustable open-ended spanner max. spanner size 24mm L.161mm	4018754299577
40260108	4026 8	Adjustable open-ended spanner max. spanner size 30mm L.207mm	4018754299584
40260110	4026 10	Adjustable open-ended spanner max. spanner size 34mm L.259mm	4018754299591
40260112	4026 12	Adjustable open-ended spanner max. spanner size 39mm L.311mm	4018754299607
40260115	4026 15	Adjustable open-ended spanner max. spanner size 44mm L.386mm	4018754299614
40260118	4026 18	Adjustable open-ended spanner max. spanner size 53mm L.462mm	4018754299621

GTIN-Code.



STAHLWILLE Eduard Wille GmbH & Co. KG

Lindenallee 27 · 42349 Wuppertal · Germany · Phone: +49 202 4791-0 · Fax: +49 202 4791-200
info@stahlwille.de · www.stahlwille.com · Copyright by STAHLWILLE Eduard Wille GmbH & Co. KG, Wuppertal
Copyright by STAHLWILLE Eduard Wille GmbH & Co. KG, Wuppertal