



Adaptor inch

447a



Product no. **02470032**
GTIN **4018754136414**
Model **447A 1/2**



Label.

Adapters 1/2" Internal square 3/8"

Technical Drawing.

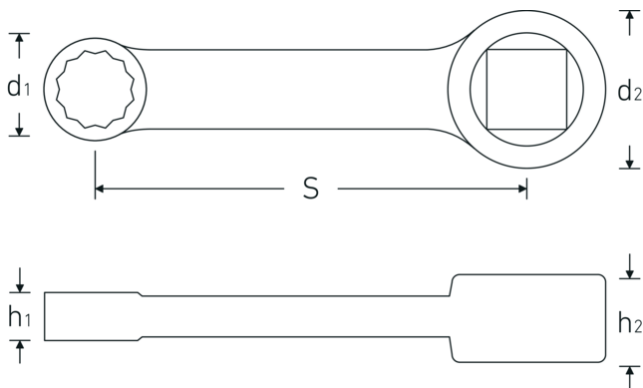

Technical Attributes.

Internal square [inch]	3/8 "
d1	19 mm
d2	19 mm
Height mm (h1)	9,2 mm
Height mm (h2)	11 mm
S	50,8 mm
Wrench size [inch]	1/2 "

Logistics data.

Depth mm (IFS)	70
Width mm (IFS)	20
Height mm (IFS)	12
Length (packed, mm)	80
Width (packed, mm)	25
Height (packed, mm)	14
Volume (packed, dm ³)	0.028 dm ³
Product no.	02470032
Weight (gross, kg)	0,060

Weight PAP (kg)	0,000
Weight PVC (kg)	0,002
GTIN	4018754136414
Country of origin	GERMANY
Region of origin	Nordrhein-Westfalen
WEEE/ElektroG	nicht ear-pflichtig
Customs tariff no.	82042000
Packing standard	1
Weight	56 g

Variants.

Product no.	Model no. (ERP)	Description	GTIN
02470016	447A 1/4	Adapters 1/4" Internal square 3/8"	4018754136377
02470020	447A 5/16	Adapters 5/16" Internal square 3/8"	4018754136384
02470024	447A 3/8	Adapters 3/8" Internal square 3/8"	4018754136391
02470028	447A 7/16	Adapters 7/16" Internal square 3/8"	4018754136407
02470032	447A 1/2	Adapters 1/2" Internal square 3/8"	4018754136414
02470034	447A 9/16	Adapters 9/16" Internal square 3/8"	4018754136421
02470036	447A 5/8	Adapters 5/8" Internal square 3/8"	4018754136438

GTIN-Code.

