

## Open-ended striking wrench

**4204**



Product no. **42040050**  
GTIN **4018754023714**  
Model **4204 50**

### Label.

Open-ended striking wrench Wrench size 50mm L.275mm

### Technical Drawing.

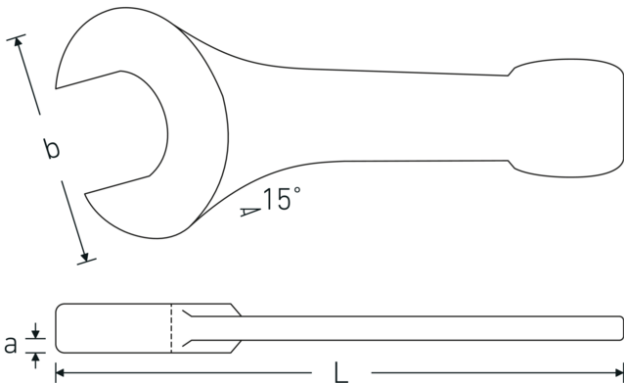

### Technical Attributes.

<b>a</b>	21 mm
<b>Width mm (b)</b>	105 mm
<b>DIN</b>	DIN 133
<b>Length mm (L)</b>	275 mm
<b>Wrench width 1 [mm]</b>	50 mm

### Logistics data.

<b>Depth mm (IFS)</b>	270
<b>Width mm (IFS)</b>	105
<b>Height mm (IFS)</b>	22
<b>Length (packed, mm)</b>	270
<b>Width (packed, mm)</b>	105
<b>Height (packed, mm)</b>	22
<b>Volume (packed, dm3)</b>	0.6237 dm3
<b>Product no.</b>	42040050
<b>Weight (gross, kg)</b>	1,450

<b>Weight PAP (kg)</b>	0,000
<b>Weight PVC (kg)</b>	0,000
<b>GTIN</b>	4018754023714
<b>Country of origin</b>	GERMANY
<b>Region of origin</b>	Nordrhein-Westfalen
<b>WEEE/ElektroG</b>	nicht ear-pflichtig
<b>Customs tariff no.</b>	82041100
<b>Packing standard</b>	1
<b>Weight</b>	1445 g

## Variants.

Product no.	Art. no. (ERP)	Description	GTIN
42040027	4204 27	Open-ended striking wrench Wrench size 27mm L.180mm	4018754023653
42040030	4204 30	Open-ended striking wrench Wrench size 30mm L.190mm	4018754023660
42040032	4204 32	Open-ended striking wrench Wrench size 32mm L.190mm	4018754023677
42040036	4204 36	Open-ended striking wrench Wrench size 36mm L.215mm	4018754023684
42040041	4204 41	Open-ended striking wrench Wrench size 41mm L.235mm	4018754023691
42040046	4204 46	Open-ended striking wrench Wrench size 46mm L.255mm	4018754023707
42040050	4204 50	Open-ended striking wrench Wrench size 50mm L.275mm	4018754023714
42040055	4204 55	Open-ended striking wrench Wrench size 55mm L.300mm	4018754023721
42040060	4204 60	Open-ended striking wrench Wrench size 60mm L.320mm	4018754023738
42040065	4204 65	Open-ended striking wrench Wrench size 65mm L.342mm	4018754023745
42040070	4204 70	Open-ended striking wrench Wrench size 70mm L.375mm	4018754023752
42040075	4204 75	Open-ended striking wrench Wrench size 75mm L.375mm	4018754023769
42040080	4204 80	Open-ended striking wrench Wrench size 80mm L.408mm	4018754023776
42040085	4204 85	Open-ended striking wrench Wrench size 85mm L.408mm	4018754023783
42040090	4204 90	Open-ended striking wrench Wrench size 90mm L.445mm	4018754023790

42040095	4204 95	Open-ended striking wrench Wrench size 95mm L.445mm	4018754023806
42040100	4204 100	Open-ended striking wrench Wrench size 100mm L.485mm	4018754023813
42040105	4204 105	Open-ended striking wrench Wrench size 105mm L.485mm	4018754023820

## GTIN-Code.

