



Ball joint puller

11703

Product no. **71070003**
GTIN **4018754346660**
Model **11703 Kugelgelenkabzieher**

Label. Ball joint puller

Product highlights.



Technical Drawing.

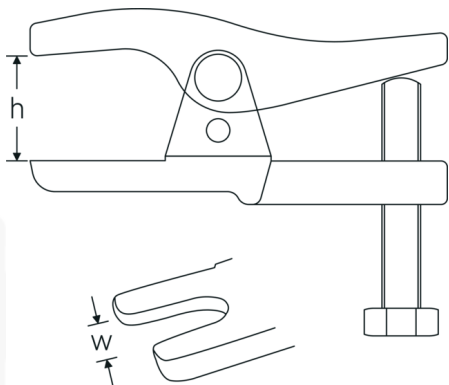

Technical Attributes.

A	35-45 mm
Clear hight (h) mm	115 mm
max. load	20 t
max. torque	200 N·m

Logistics data.

Depth mm (IFS)	235
Width mm (IFS)	140
Height mm (IFS)	105
Length (packed, mm)	325
Width (packed, mm)	140
Height (packed, mm)	105
Volume (packed, dm3)	4.7775 dm3
Product no.	71070003
Weight (gross, kg)	2,940
Weight PAP (kg)	0,224
Weight PVC (kg)	0,000
GTIN	4018754346660
Country of origin	GERMANY
Region of origin	Nordrhein-Westfalen
WEEE/ElektroG	nicht ear-pflichtig
Customs tariff no.	82055980
Packing standard	1
Weight	2900 g

Variants.

Product no.	Art. no. (ERP)	Description	GTIN
71070003	11703 Kugelgelenkabzieher	Ball joint puller	4018754346660

GTIN-Code.

