



IMPACT-TORX® screwdriver sockets 1/2"

2307TX

Product no. 23070030
GTIN 4018754015221
Model 2307TX IMP T 30



Label. IMPACT screwdriver socket 1/2 " T30 L.40mm

- Features.**
- for recessed TORX® screws
 - 1/2" internal square drive
 - Chrome Alloy Steel, gunmetal finish

Product highlights.



Optimised functionality.

All IMPACT sockets have a through cross hole for the connecting pin and a deep groove for the rubber locking ring. The locking pin is not stressed during use.

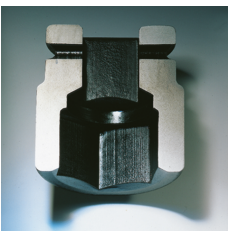

High fitting accuracy.

The high fitting accuracy due to tight tolerances guarantees optimum, backlash-free transmission of forces to the socket.

Technical Drawing.

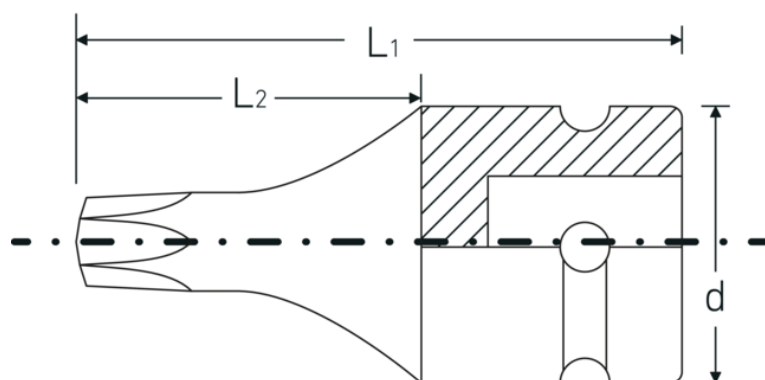

Technical Attributes.

Drive profile	TORX®
TORX® drive profile (mm)	5,5 mm
Internal square drive (inch)	1/2 "
d	25 mm
Size of output profile	T30
L1	40 mm
L2	21 mm

Logistics data.

Depth mm (IFS)	40
Width mm (IFS)	25
Height mm (IFS)	25
WEEE/ElektroG	nicht ear-pflichtig
Length (packed, mm)	105
Width (packed, mm)	45
Height (packed, mm)	26
Volume (packed, dm3)	0.12285 dm3
Product no.	23070030
Weight (gross, kg)	0,291
Weight PAP (kg)	0,000
Weight PVC (kg)	0,005
GTIN	4018754015221
Country of origin AWR	GERMANY
Region of origin	Nordrhein-Westfalen
Customs tariff no.	82042000
Packing standard	5
Weight	57 g

Variants.

Product no.	Model no. (ERP)	Description	GTIN
23070030	2307TX IMP T 30	IMPACT screwdriver socket 1/2 " T30 L.40mm	4018754015221
23070040	2307TX IMP T 40	IMPACT screwdriver socket 1/2 " T40 L.40mm	4018754015238
23070045	2307TX IMP T 45	IMPACT screwdriver socket 1/2 " T45 L.40mm	4018754154012

23070050	2307TX IMP T 50	IMPACT screwdriver socket 1/2 " T50 L.40mm	4018754015245
23070055	2307TX IMP T 55	IMPACT screwdriver socket 1/2 " T55 L.40mm	4018754015252
23070060	2307TX IMP T 60	IMPACT screwdriver socket 1/2 " T60 L.40mm	4018754015269

GTIN-Code.



Accessories.



39022030
IMPACT locking pin



39011940
IMPACT rubber ring