



Adjustable open-ended spanner, metric

4026



Product no. **40260104**
GTIN **4018754299560**
Model **4026 4**

Label. Adjustable open-ended spanner max.size 13mm L.115mm

- Features.**
- left-handed
 - DIN 3117/ISO 6787 (B shape)
 - ASME B 107.100
 - jaw offset 22.5°
 - Chrome-Vanadium, gunmetal finish

Technical Drawing.

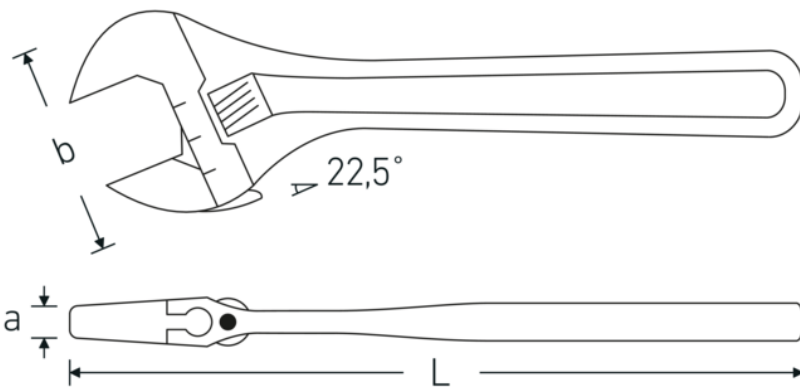

Technical Attributes.

a	9,5 mm
Width mm (b)	35 mm
DIN	DIN 3117 / ISO 6787 Form B
Size	4

Logistics data.

Depth mm (IFS)	115
Width mm (IFS)	32
Height mm (IFS)	9
Length (packed, mm)	117

Length mm (L)	115 mm	Width (packed, mm)	38
Spanner size max.	13 mm	Height (packed, mm)	39
		Volume (packed, dm3)	0.173394 dm3
		Product no.	40260104
		Weight (gross, kg)	0,250
		Weight PAP (kg)	0,000
		Weight PVC (kg)	0,006
		GTIN	4018754299560
		Country of origin AWR	SPAIN
		Region of origin	Ausländischer Ursprung
		WEEE/ElektroG	nicht ear-pflichtig
		Customs tariff no.	82041200
		Packing standard	5
		Weight	52 g

Variants.

Product no.	Model no. (ERP)	Description	GTIN
40260104	4026 4	Adjustable open-ended spanner max.size 13mm L.115mm	4018754299560
40260106	4026 6	Adjustable open-ended spanner max.size 24mm L.161mm	4018754299577
40260108	4026 8	Adjustable open-ended spanner max.size 30mm L.207mm	4018754299584
40260110	4026 10	Adjustable open-ended spanner max.size 34mm L.259mm	4018754299591
40260112	4026 12	Adjustable open-ended spanner max.size 39mm L.311mm	4018754299607
40260115	4026 15	Adjustable open-ended spanner max.size 44mm L.386mm	4018754299614
40260118	4026 18	Adjustable open-ended spanner max.size 53mm L.462mm	4018754299621

GTIN-Code.





STAHLWILLE Eduard Wille GmbH & Co. KG

Lindenallee 27 · 42349 Wuppertal · Germany · Phone: +49 202 4791-0 · Fax: +49 202 4791-200
info@stahlwille.de · www.stahlwille.com · Copyright by STAHLWILLE Eduard Wille GmbH & Co. KG, Wuppertal
Copyright by STAHLWILLE Eduard Wille GmbH & Co. KG, Wuppertal