



**Adjustable open-ended wrench,
metric**

4026



Product no. **40260112**
GTIN **4018754299607**
Model **4026 12**

Label. Adjustable open-ended wrench max. wrench size 39mm L.311mm

Technical Drawing.

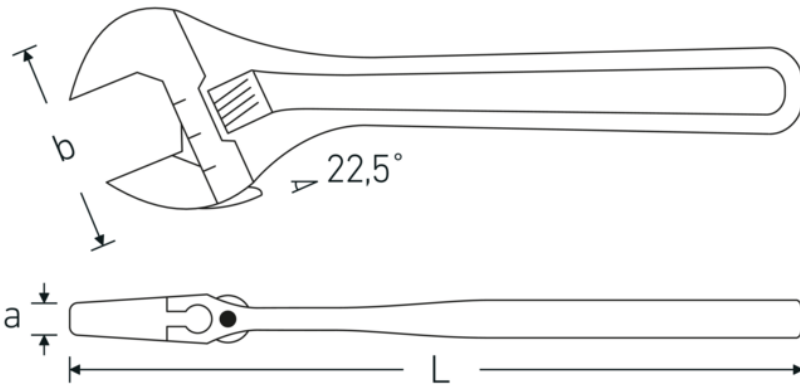

Technical Attributes.

a	19 mm
Width mm (b)	84 mm
DIN	DIN 3117 / ISO 6787 Form B
Size	12
Length mm (L)	311 mm
Wrench width max.	39 mm

Logistics data.

Depth mm (IFS)	310
Width mm (IFS)	80
Height mm (IFS)	18
Length (packed, mm)	312
Width (packed, mm)	110
Height (packed, mm)	54
Volume (packed, dm3)	1.85328 dm3
Product no.	40260112
Weight (gross, kg)	3,495

Weight PAP (kg)	0,000
Weight PVC (kg)	0,016
GTIN	4018754299607
Country of origin AWR	SPAIN
Region of origin	Ausländischer Ursprung
WEEE/ElektroG	nicht ear-pflichtig
Customs tariff no.	82041200
Packing standard	5
Weight	805 g

Variants.

Product no.	Model no. (ERP)	Description	GTIN
40260104	4026 4	Adjustable open-ended wrench max. wrench size 13mm L.115mm	4018754299560
40260106	4026 6	Adjustable open-ended wrench max. wrench size 24mm L.161mm	4018754299577
40260108	4026 8	Adjustable open-ended wrench max. wrench size 30mm L.207mm	4018754299584
40260110	4026 10	Adjustable open-ended wrench max. wrench size 34mm L.259mm	4018754299591
40260112	4026 12	Adjustable open-ended wrench max. wrench size 39mm L.311mm	4018754299607
40260115	4026 15	Adjustable open-ended wrench max. wrench size 44mm L.386mm	4018754299614
40260118	4026 18	Adjustable open-ended wrench max. wrench size 53mm L.462mm	4018754299621

GTIN-Code.

