



IMPACT sockets 1/2"

50IMP

Product no. **23010011**
GTIN **4018754014965**
Model **50 IMP 11**



Label. IMPACT socket 1/2 " 11mm L.38mm

- Features.**
- with hex
 - 1/2" internal square drive
 - DIN 3129 / ISO 1711-2
 - Chrome Alloy Steel, gunmetal finish

Product highlights.



Powerful and resilient.

The sockets are made from high-quality Chrome Alloy Steel. They are hardened in oil to prevent stress and distortion.



Optimised functionality.

All IMPACT sockets have a through cross hole for the connecting pin and a deep groove for the rubber locking ring. The locking pin is not stressed during use.



High fitting accuracy.

The high fitting accuracy due to tight tolerances guarantees optimum, backlash-free transmission of forces to the socket.

Technical Drawing.

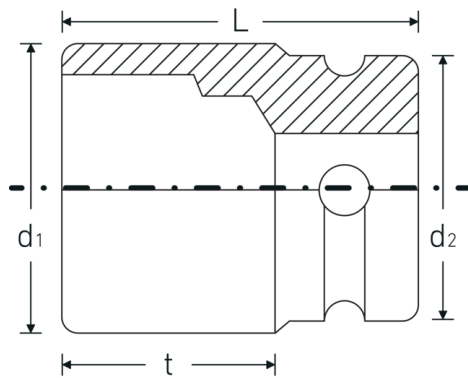

Technical Attributes.

Drive profile	hex
Internal square drive (inch)	1/2 "
d1	18,1 mm
d2	25 mm
DIN	DIN 3129 / ISO 1711-2
Length mm (L)	38 mm
Spanner size [mm]	11 mm
t	21,5 mm

Logistics data.

Depth mm (IFS)	38
Width mm (IFS)	25
Height mm (IFS)	25
WEEE/ElektroG	nicht ear-pflichtig
Length (packed, mm)	140
Width (packed, mm)	60
Height (packed, mm)	40
Volume (packed, dm3)	0.336 dm3
Product no.	23010011
Weight (gross, kg)	0,900
Weight PAP (kg)	0,000
Weight PVC (kg)	0,006
GTIN	4018754014965
Country of origin AWR	GERMANY
Region of origin	Nordrhein-Westfalen
Customs tariff no.	82042000
Packing standard	10
Weight	88 g

Variants.

Product no.	Model no. (ERP)	Description	GTIN
23010008	50 IMP 8	IMPACT socket 1/2 " 8mm L.38mm	4018754233731
23010010	50 IMP 10	IMPACT socket 1/2 " 10mm L.38mm	4018754014958
23010011	50 IMP 11	IMPACT socket 1/2 " 11mm L.38mm	4018754014965

23010012	50 IMP 12	IMPACT socket 1/2 " 12mm L.38mm	4018754233748
23010013	50 IMP 13	IMPACT socket 1/2 " 13mm L.38mm	4018754014989
23010014	50 IMP 14	IMPACT socket 1/2 " 14mm L.38mm	4018754014996
23010015	50 IMP 15	IMPACT socket 1/2 " 15mm L.38mm	4018754015009
23010016	50 IMP 16	IMPACT socket 1/2 " 16mm L.38mm	4018754015016
23010017	50 IMP 17	IMPACT socket 1/2 " 17mm L.38mm	4018754015023
23010018	50 IMP 18	IMPACT socket 1/2 " 18mm L.38mm	4018754015030
23010019	50 IMP 19	IMPACT socket 1/2 " 19mm L.40mm	4018754015047
23010021	50 IMP 21	IMPACT socket 1/2 " 21mm L.40mm	4018754015061
23010022	50 IMP 22	IMPACT socket 1/2 " 22mm L.42mm	4018754015078
23010023	50 IMP 23	IMPACT socket 1/2 " 23mm L.40mm	4018754233755
23010024	50 IMP 24	IMPACT socket 1/2 " 24mm L.44mm	4018754015092
23010025	50 IMP 25	IMPACT socket 1/2 " 25mm L.44mm	4018754233762
23010027	50 IMP 27	IMPACT socket 1/2 " 27mm L.45mm	4018754015122
23010030	50 IMP 30	IMPACT socket 1/2 " 30mm L.50mm	4018754233779
23010032	50 IMP 32	IMPACT socket 1/2 " 32mm L.50mm	4018754233786

GTIN-Code.



Accessories.



39022030
IMPACT locking pin



39011940
IMPACT rubber ring

STAHLWILLE Eduard Wille GmbH & Co. KG

Lindenallee 27 · 42349 Wuppertal · Germany · Phone: +49 202 4791-0 · Fax: +49 202 4791-200

info@stahlwille.de · www.stahlwille.com · Copyright by STAHLWILLE Eduard Wille GmbH & Co. KG, Wuppertal

Copyright by STAHLWILLE Eduard Wille GmbH & Co. KG, Wuppertal