



Adjustable open-ended wrench, metric

4025



Product no. **40250106**
GTIN **4018754299508**
Model **4025 6**

Label. Adjustable open-ended wrench max. wrench size 24mm L.161mm

Technical Drawing.

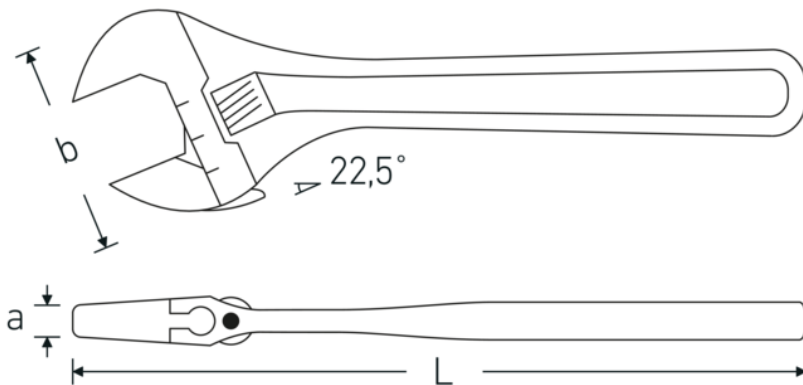

Technical Attributes.

a	10,8 mm
Width mm (b)	50 mm
DIN	DIN 3117 / ISO 6787 Form B
Size	6
Length mm (L)	161 mm
Wrench width max.	24 mm

Logistics data.

Depth mm (IFS)	160
Width mm (IFS)	48
Height mm (IFS)	11
Length (packed, mm)	163
Width (packed, mm)	63
Height (packed, mm)	41
Volume (packed, dm3)	0.421029 dm3
Product no.	40250106
Weight (gross, kg)	0,650

Weight PAP (kg)	0,000
Weight PVC (kg)	0,009
GTIN	4018754299508
Country of origin AWR	SPAIN
Region of origin	Ausländischer Ursprung
WEEE/ElektroG	nicht ear-pflichtig
Customs tariff no.	82041200
Packing standard	5
Weight	155 g

Variants.

Product no.	Model no. (ERP)	Description	GTIN
40250104	4025 4	Adjustable open-ended wrench max. wrench size 13mm L.115mm	4018754299492
40250106	4025 6	Adjustable open-ended wrench max. wrench size 24mm L.161mm	4018754299508
40250108	4025 8	Adjustable open-ended wrench max. wrench size 30mm L.207mm	4018754299515
40250110	4025 10	Adjustable open-ended wrench max. wrench size 34mm L.259mm	4018754299522
40250112	4025 12	Adjustable open-ended wrench max. wrench size 39mm L.311mm	4018754299539
40250115	4025 15	Adjustable open-ended wrench max. wrench size 44mm L.386mm	4018754299546
40250118	4025 18	Adjustable open-ended wrench max. wrench size 53mm L.462mm	4018754299553

GTIN-Code.

