



IMPACT sockets 3/4"

55IMP

Product no. 25010017
GTIN 4018754015597
Model 55 IMP 17



Label. IMPACT socket 3/4 " 17mm L.48mm

- Features.**
- with hex
 - 3/4" internal square drive
 - Chrome Alloy Steel, gunmetal finish
 - DIN 3129 / ISO 1711-2

Product highlights.



Powerful and resilient.

The sockets are made from high-quality Chrome Alloy Steel. They are hardened in oil to prevent stress and distortion.



Optimized functionality.

All IMPACT sockets have a through cross hole for the connecting pin and a deep groove for the rubber locking ring. The locking pin is not stressed during use.

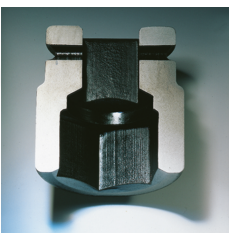

High fitting accuracy.

The high precision fit, achieved through tight tolerances, ensures optimal, backlash-free transmission of forces to the socket.

Technical Drawing.

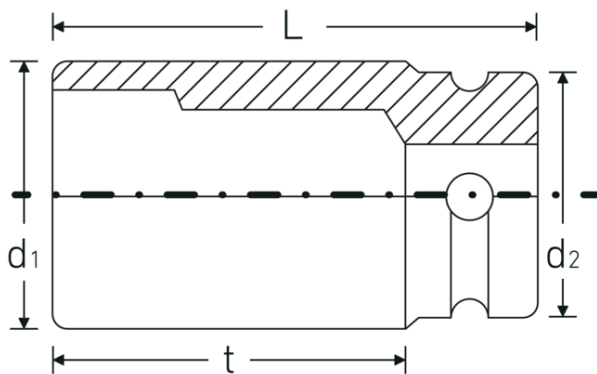

Technical Attributes.

Drive profile	hex
Internal square drive (inch)	3/4 "
d1	29 mm
d2	44 mm
DIN	DIN 3129 / ISO 1711-2
Length mm (L)	48 mm
Width across flats [mm]	17 mm
t	23 mm

Logistics data.

Depth mm (IFS)	50
Width mm (IFS)	44
Height mm (IFS)	40
WEEE/ElektroG	nicht ear-pflichtig
Length (packed, mm)	221
Width (packed, mm)	45
Height (packed, mm)	51
Volume (packed, dm3)	0.507195 dm3
Product no.	25010017
Weight (gross, kg)	1,825
Weight PAP (kg)	0,000
Weight PVC (kg)	0,008
GTIN	4018754015597
Country of origin AWR	GERMANY
Region of origin	Nordrhein-Westfalen
Customs tariff no.	82042000
Packing standard	5
Weight	365 g

Variants.

Product no.	Model no. (ERP)	Description	GTIN
25010017	55 IMP 17	IMPACT socket 3/4 " 17mm L.48mm	4018754015597
25010018	55 IMP 18	IMPACT socket 3/4 " 18mm L.48mm	4018754015603
25010019	55 IMP 19	IMPACT socket 3/4 " 19mm L.48mm	4018754015610

25010021	55 IMP 21	IMPACT socket 3/4 " 21mm L.50mm	4018754015634
25010022	55 IMP 22	IMPACT socket 3/4 " 22mm L.50mm	4018754015641
25010024	55 IMP 24	IMPACT socket 3/4 " 24mm L.50mm	4018754015665
25010027	55 IMP 27	IMPACT socket 3/4 " 27mm L.51mm	4018754015696
25010028	55 IMP 28	IMPACT socket 3/4 " 28mm L.54mm	4018754015702
25010029	55 IMP 29	IMPACT socket 3/4 " 29mm L.54mm	4018754015719
25010030	55 IMP 30	IMPACT socket 3/4 " 30mm L.54mm	4018754015726
25010032	55 IMP 32	IMPACT socket 3/4 " 32mm L.54mm	4018754015733
25010033	55 IMP 33	IMPACT socket 3/4 " 33mm L.54mm	4018754015740
25010034	55 IMP 34	IMPACT socket 3/4 " 34mm L.54mm	4018754015757
25010036	55 IMP 36	IMPACT socket 3/4 " 36mm L.57mm	4018754015771
25010038	55 IMP 38	IMPACT socket 3/4 " 38mm L.58mm	4018754015795
25010041	55 IMP 41	IMPACT socket 3/4 " 41mm L.58mm	4018754233885
25010046	55 IMP 46	IMPACT socket 3/4 " 46mm L.63mm	4018754233892

GTIN-Code.



Accessories.



39013650
IMPACT rubber ring



39023540
IMPACT locking pin