

4204



Art. no. **42040090**  
 GTIN **4018754023790**  
 Model **4204 90**

**Label.** Stl. 90mm L.445mm

**Features.**

- DIN 133
- specialstål, stålgrå

## Technical Drawing.

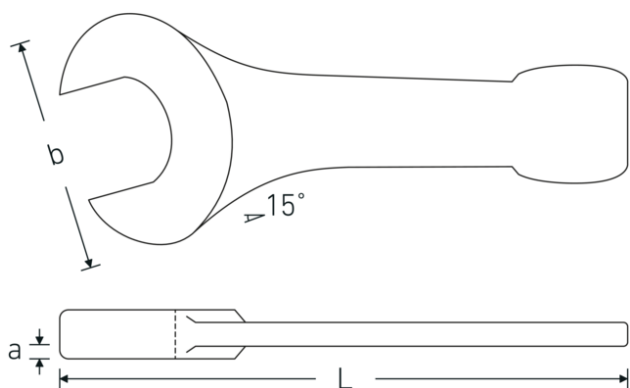

## Technical Attributes.

a	38 mm
Bredd mm (b)	194 mm
DIN	DIN 133
Längd mm (L)	445 mm
Nyckelstorlek 1 [mm]	90 mm

## Logistics data.

Djup mm (IFS)	445
Bredd mm (IFS)	194
Höjd mm (IFS)	38
Längd (packad, mm)	445
Bredd (packad, mm)	194
Höjd (packad, mm)	38
Volym (förpackad, dm3)	3.28054 dm3

<b>Art. no.</b>	42040090
<b>Vikt (brutto, kg)</b>	7,390
<b>Vikt PAP (kg)</b>	0,000
<b>Vikt PVC (kg)</b>	0,000
<b>GTIN</b>	4018754023790
<b>Ursprungsland AWR</b>	GERMANY
<b>Ursprungsregion</b>	Nordrhein-Westfalen
<b>WEEE/ElektroG</b>	nicht ear-pflichtig
<b>Tulltaxa nr.</b>	82041100
<b>Förpackningsstandard</b>	1
<b>Vikt (g)</b>	7390 g

## Variants.

Art. no.	Modell no. (ERP)	Beteckning	GTIN
42040027	4204 27	Stl. 27mm L.180mm	4018754023653
42040030	4204 30	Stl. 30mm L.190mm	4018754023660
42040032	4204 32	Stl. 32mm L.190mm	4018754023677
42040036	4204 36	Stl. 36mm L.215mm	4018754023684
42040041	4204 41	Stl. 41mm L.235mm	4018754023691
42040046	4204 46	Stl. 46mm L.255mm	4018754023707
42040050	4204 50	Stl. 50mm L.275mm	4018754023714
42040055	4204 55	Stl. 55mm L.300mm	4018754023721
42040060	4204 60	Stl. 60mm L.320mm	4018754023738
42040065	4204 65	Stl. 65mm L.342mm	4018754023745
42040070	4204 70	Stl. 70mm L.375mm	4018754023752
42040075	4204 75	Stl. 75mm L.375mm	4018754023769
42040080	4204 80	Stl. 80mm L.408mm	4018754023776
42040085	4204 85	Stl. 85mm L.408mm	4018754023783
42040090	4204 90	Stl. 90mm L.445mm	4018754023790
42040095	4204 95	Stl. 95mm L.445mm	4018754023806
42040100	4204 100	Stl. 100mm L.485mm	4018754023813
42040105	4204 105	Stl. 105mm L.485mm	4018754023820

## GTIN-Code.

