



## Adjustable open-ended wrench, metric

**4026**



Product no. **40260108**  
GTIN **4018754299584**  
Model **4026 8**

**Label.** Adjustable open-ended wrench max. wrench size 30mm L.207mm

### Technical Drawing.

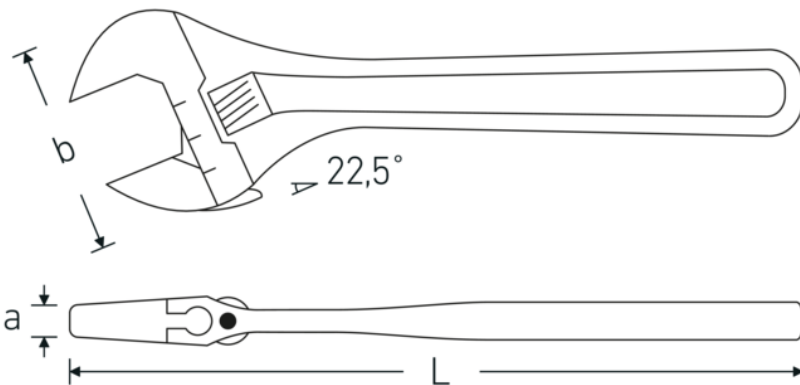

### Technical Attributes.

<b>a</b>	14 mm
<b>Width mm (b)</b>	62 mm
<b>DIN</b>	DIN 3117 / ISO 6787 Form B
<b>Size</b>	8
<b>Length mm (L)</b>	207 mm
<b>Wrench width max.</b>	30 mm

### Logistics data.

<b>Depth mm (IFS)</b>	206
<b>Width mm (IFS)</b>	57
<b>Height mm (IFS)</b>	13
<b>Length (packed, mm)</b>	213
<b>Width (packed, mm)</b>	67
<b>Height (packed, mm)</b>	50
<b>Volume (packed, dm3)</b>	0.71355 dm3
<b>Product no.</b>	40260108
<b>Weight (gross, kg)</b>	1,235

<b>Weight PAP (kg)</b>	0,000
<b>Weight PVC (kg)</b>	0,010
<b>GTIN</b>	4018754299584
<b>Country of origin AWR</b>	SPAIN
<b>Region of origin</b>	Ausländischer Ursprung
<b>WEEE/ElektroG</b>	nicht ear-pflichtig
<b>Customs tariff no.</b>	82041200
<b>Packing standard</b>	5
<b>Weight</b>	310 g

## Variants.

Product no.	Model no. (ERP)	Description	GTIN
40260104	4026 4	Adjustable open-ended wrench max. wrench size 13mm L.115mm	4018754299560
40260106	4026 6	Adjustable open-ended wrench max. wrench size 24mm L.161mm	4018754299577
40260108	4026 8	Adjustable open-ended wrench max. wrench size 30mm L.207mm	4018754299584
40260110	4026 10	Adjustable open-ended wrench max. wrench size 34mm L.259mm	4018754299591
40260112	4026 12	Adjustable open-ended wrench max. wrench size 39mm L.311mm	4018754299607
40260115	4026 15	Adjustable open-ended wrench max. wrench size 44mm L.386mm	4018754299614
40260118	4026 18	Adjustable open-ended wrench max. wrench size 53mm L.462mm	4018754299621

## GTIN-Code.

