

Open-ended striking wrench

4204



Product no. **42040046**
GTIN **4018754023707**
Model **4204 46**

Label.

Open-ended striking wrench Wrench size 46mm L.255mm

Technical Drawing.

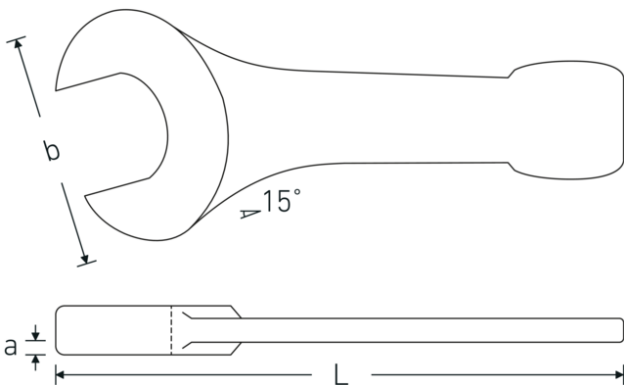

Technical Attributes.

| | |
|----------------------------|---------|
| a | 20 mm |
| Width mm (b) | 98 mm |
| DIN | DIN 133 |
| Length mm (L) | 255 mm |
| Wrench width 1 [mm] | 46 mm |

Logistics data.

| | |
|-----------------------------|------------|
| Depth mm (IFS) | 252 |
| Width mm (IFS) | 100 |
| Height mm (IFS) | 22 |
| Length (packed, mm) | 252 |
| Width (packed, mm) | 100 |
| Height (packed, mm) | 22 |
| Volume (packed, dm3) | 0.5544 dm3 |
| Product no. | 42040046 |
| Weight (gross, kg) | 1,245 |

| | |
|------------------------------|---------------------|
| Weight PAP (kg) | 0,000 |
| Weight PVC (kg) | 0,000 |
| GTIN | 4018754023707 |
| Country of origin AWR | GERMANY |
| Region of origin | Nordrhein-Westfalen |
| WEEE/ElektroG | nicht ear-pflichtig |
| Customs tariff no. | 82041100 |
| Packing standard | 1 |
| Weight | 1245 g |

Variants.

| Product no. | Model no. (ERP) | Description | GTIN |
|-------------|-----------------|---|---------------|
| 42040027 | 4204 27 | Open-ended striking wrench Wrench size 27mm L.180mm | 4018754023653 |
| 42040030 | 4204 30 | Open-ended striking wrench Wrench size 30mm L.190mm | 4018754023660 |
| 42040032 | 4204 32 | Open-ended striking wrench Wrench size 32mm L.190mm | 4018754023677 |
| 42040036 | 4204 36 | Open-ended striking wrench Wrench size 36mm L.215mm | 4018754023684 |
| 42040041 | 4204 41 | Open-ended striking wrench Wrench size 41mm L.235mm | 4018754023691 |
| 42040046 | 4204 46 | Open-ended striking wrench Wrench size 46mm L.255mm | 4018754023707 |
| 42040050 | 4204 50 | Open-ended striking wrench Wrench size 50mm L.275mm | 4018754023714 |
| 42040055 | 4204 55 | Open-ended striking wrench Wrench size 55mm L.300mm | 4018754023721 |
| 42040060 | 4204 60 | Open-ended striking wrench Wrench size 60mm L.320mm | 4018754023738 |
| 42040065 | 4204 65 | Open-ended striking wrench Wrench size 65mm L.342mm | 4018754023745 |
| 42040070 | 4204 70 | Open-ended striking wrench Wrench size 70mm L.375mm | 4018754023752 |
| 42040075 | 4204 75 | Open-ended striking wrench Wrench size 75mm L.375mm | 4018754023769 |
| 42040080 | 4204 80 | Open-ended striking wrench Wrench size 80mm L.408mm | 4018754023776 |
| 42040085 | 4204 85 | Open-ended striking wrench Wrench size 85mm L.408mm | 4018754023783 |
| 42040090 | 4204 90 | Open-ended striking wrench Wrench size 90mm L.445mm | 4018754023790 |

| | | | |
|----------|----------|---|---------------|
| 42040095 | 4204 95 | Open-ended striking wrench Wrench size 95mm L.445mm | 4018754023806 |
| 42040100 | 4204 100 | Open-ended striking wrench Wrench size 100mm L.485mm | 4018754023813 |
| 42040105 | 4204 105 | Open-ended striking wrench Wrench size 105mm L.485mm | 4018754023820 |

GTIN-Code.

