

IMPACT sockets 1/2"

51IMP



Product no. **23020017**
GTIN **4018754015153**
Model **51 IMP 17**



Label. IMPACT socket 1/2 " 17mm L.85mm

- Features.**
- long version
 - with hex
 - 1/2" internal square drive
 - Chrome Alloy Steel, gunmetal finish
 - DIN 3129 / ISO 1711-2

Product highlights.



Powerful and resilient.

The sockets are made from high-quality Chrome Alloy Steel. They are hardened in oil to prevent stress and distortion.



Optimized functionality.

All IMPACT sockets have a through cross hole for the connecting pin and a deep groove for the rubber locking ring. The locking pin is not stressed during use.



High fitting accuracy.

The high precision fit, achieved through tight tolerances, ensures optimal, backlash-free transmission of forces to the socket.

Technical Drawing.

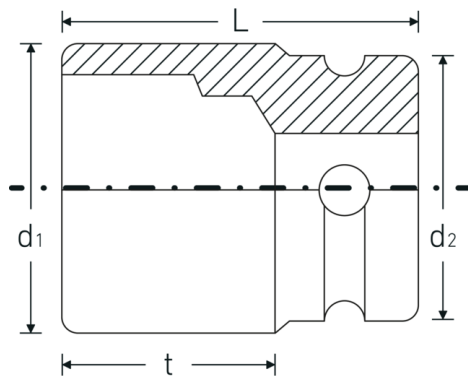

Technical Attributes.

Drive profile	hex
Internal square drive (inch)	1/2 "
d1	26,2 mm
d2	30 mm
Length mm (L)	85 mm
Width across flats [mm]	17 mm
t	68 mm

Logistics data.

Depth mm (IFS)	85
Width mm (IFS)	30
Height mm (IFS)	30
WEEE/ElektroG	nicht ear-pflichtig
Length (packed, mm)	151
Width (packed, mm)	31
Height (packed, mm)	86
Volume (packed, dm3)	0.402566 dm3
Product no.	23020017
Weight (gross, kg)	1,600
Weight PAP (kg)	0,000
Weight PVC (kg)	0,008
GTIN	4018754015153
Country of origin AWR	GERMANY
Region of origin	Nordrhein-Westfalen
Customs tariff no.	82042000
Packing standard	5
Weight	318 g

Variants.

Product no.	Model no. (ERP)	Description	GTIN
23020013	51 IMP 13	IMPACT socket 1/2 " 13mm L.85mm	4018754015139
23020015	51 IMP 15	IMPACT socket 1/2 " 15mm L.85mm	4018754158126
23020016	51 IMP 16	IMPACT socket 1/2 " 16mm L.85mm	4018754015146

23020017	51 IMP 17	IMPACT socket 1/2 " 17mm L.85mm	4018754015153
23020018	51 IMP 18	IMPACT socket 1/2 " 18mm L.85mm	4018754015160
23020019	51 IMP 19	IMPACT socket 1/2 " 19mm L.85mm	4018754015177
23020021	51 IMP 21	IMPACT socket 1/2 " 21mm L.85mm	4018754015184
23020022	51 IMP 22	IMPACT socket 1/2 " 22mm L.85mm	4018754015191
23020024	51 IMP 24	IMPACT socket 1/2 " 24mm L.85mm	4018754015207
23020027	51 IMP 27	IMPACT socket 1/2 " 27mm L.85mm	4018754015214

GTIN-Code.

