



Torque tester

SmartCheck 400 USB

Product no.	96521209
GTIN	4018754324873
Model	SMARTCHECK 400 USB



Label.

Torque testing device SmartCheck USB Measuring r.40-400N·m Internal square 3/4"

Features.

- for testing indicating and triggering torque wrenches
- with interchangeable square drive adapters for square drives (from 3/8" to 1/4" with SmartCheck 100 USB; from 3/4" to 1/2" for SmartCheck 400 USB)
- large LCD for optimum readability
- the display, the display holder, and the base can be rotated 180°
- compact design
- waterproof display and foil keyboard; case made of impact-resistant plastic
- simple installation thanks to pre-drilled holes in the mounting bracket
- horizontal or vertical installations
- for controlled right and left-hand torque testing
- 3 operating modes: running display of the applied torque (Track), display of the torque on triggering/kink point detection (First-Peak), peak value display (Peak-Hold)
- customised input of target torques and tolerances for evaluating the measured value possible
- with integrated visual and acoustic overload protection
- 3 measuring units (N·m, ft·lb, in·lb)
- micro USB interface for data export and for optional power supply
- data storage for up to 200 data records, including date and time stamp
- CheckMaster documentation software for transferring values and creating test certificates is available free of charge at www.stahlwille.de
- operation via included power supply, batteries or rechargeable batteries (4 x AAA or 1 x 9V block, including adapter)
- with factory calibration certificate
- delivered in a sturdy plastic box
- **display deviation $\pm 1\%$**

Advantages.

Electronic testing device for checking and adjusting indicating and triggering torque wrenches.

Measurement in the large torque range from 1 to 1.500 N·m.

The large LCD can be rotated 180° and is easy to read from any position.

Simple, quick and reliable testing of torque wrenches to ensure quality in production.

Simple documentation of the measured values on the PC via USB interface.



Product highlights.



Flexible mounting.

Whether mounted horizontally or vertically, the well-designed mounting points, compact design and rotatable display allow flexible positioning anywhere in the workshop.



Optimum viewing angle.

The compact testing device can be adjusted to the optimum individual viewing angle. The display can be viewed from practically anywhere, as not only the large LCD, but also the display holder and the base body can be rotated by 180°.



Communication and power supply via USB.

SmartCheck is equipped with a convenient micro-USB interface that allows stored test values to be read out and simplifies their transfer to external systems. The USB port also serves as an optional power supply for the device.



Comprehensive documentation.

The SmartCheck testing device can be easily configured with the CheckMaster software allowing direct evaluation of the measurement results. In this way, all data can be read out and saved on the PC for better monitoring and optimization of work processes.



Plug and work.

Our SmartCheck is intuitive to use and is ready for immediate use. It is space-saving and offers versatile mounting options for flexible installation. The device can be operated using a power supply or batteries and can therefore be easily positioned at any workstation, even if there is no power socket available.

Technical Drawing.

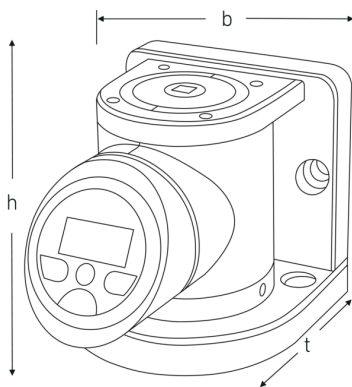

Technical Attributes.

Measuring range N-m	40-400 N-m
Internal square [inch]	3/4 "
Measuring range ft-lb	30-295 ft-lb
Measuring range in-lb	354-3540 in-lb
Number of digits	4
Width mm (b)	120 mm
Weight with box	7036 g
Height mm (h)	124 mm
Model no.	SmartCheck USB 400
t	167 mm

Logistics data.

Depth mm (IFS)	395
Width mm (IFS)	315
Height mm (IFS)	145
WEEE/ElektroG	Kleingeräte B2C
Length (packed, mm)	395
Width (packed, mm)	315
Height (packed, mm)	145
Volume (packed, dm3)	18.041625 dm3
Product no.	96521209
Weight (gross, kg)	7,210
Weight PAP (kg)	0,156
Weight PVC (kg)	0,000
GTIN	4018754324873
Country of origin AWR	GERMANY
Region of origin	Nordrhein-Westfalen
Customs tariff no.	90318080
Packing standard	1
Weight	5690 g

Parts list.



81500004
Plastic box, empty



52110063
USB mains adapter



83230103
Soft foam inserts



83230102
Soft foam inserts



91100522
Packaging material



51110057
USB cable

Variants.

Product no.	Model no. (ERP)	Description	GTIN
96521206	SMARTCHECK 10S USB	Torque screwdriver testing device SmartCheck USB Measuring r.1-10N·m Internal square 1/4"	4018754324842
96521207	SMARTCHECK 10 USB	Torque testing device SmartCheck USB Measuring r.1-10N·m Internal square 1/4"	4018754324859
96521208	SMARTCHECK 100 USB	Torque testing device SmartCheck USB Measuring r.10-100N·m Internal square 3/8"	4018754324866
96521209	SMARTCHECK 400 USB	Torque testing device SmartCheck USB Measuring r.40-400N·m Internal square 3/4"	4018754324873
96521210	SMARTCHECK 800 USB	Torque testing device SmartCheck USB Measuring r.80-800N·m Internal square 3/4"	4018754324880
96521211	SMARTCHECK 1500 USB	Torque testing device SmartCheck USB Measuring r.150-1500N·m Internal square 1"	4018754331352

GTIN-Code.



Images.

