



Verstelbare moersleutel, metrisch

4026



Artikelnr. **40260108**
GTIN **4018754299584**
Model **4026 8**

Aanwijzing.

Verstelbare moersleutel max.m. 30mm L.207mm

Eigenschappen.

- rechtsdraaiend
- DIN 3117/ISO 6787 model B
- ASME B 107.100
- bekstand 22,5°
- Chroom-Vanadium, gefosfateerd

Voordelen.

linksdraaiend

Technische tekening.

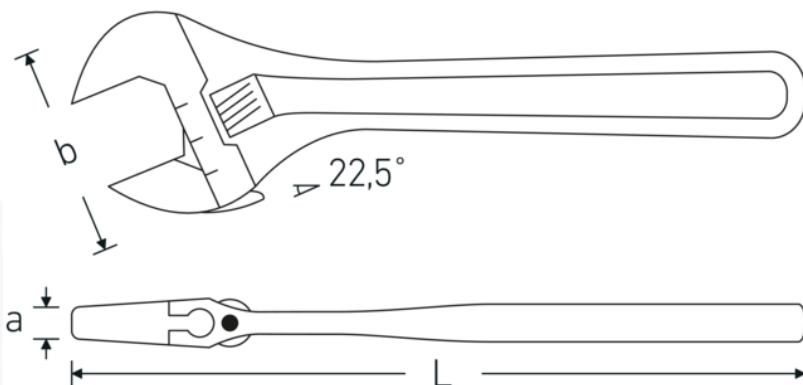

Technische kenmerken.

a	14 mm
Breedte mm (b)	62 mm
DIN	DIN 3117 / ISO 6787 Form B
Gr.	8
Lengte mm (L)	207 mm
Sleutelmaat max.	30 mm

Logistieke gegevens.

Diepte mm (IFS)	206
Breedte mm (IFS)	57
Hoogte mm (IFS)	13
Lengte (verpakt, mm)	213
Breedte (verpakt, mm)	67
Hoogte (verpakt, mm)	50
Volume (verpakt, dm3)	0.71355 dm3
Artikelnr.	40260108
Gewicht (bruto, KG)	1,235
Gewicht PAP (KG)	0,000
Gewicht PVC (KG)	0,010
GTIN	4018754299584
Land van oorsprong AWR	SPAIN
Regio van oorsprong	Ausländischer Ursprung
WEEE/ElektroG	nicht ear-pflichtig
Douanetarief nr.	82041200
Verpakkingsstandaard	5
Gewicht (g)	310 g

Varianten.

Artikelnr.	Modelnr. (ERP)	Beschrijving	GTIN
40260104	4026 4	Verstelbare moersleutel max.m. 13mm L.115mm	4018754299560
40260106	4026 6	Verstelbare moersleutel max.m. 24mm L.161mm	4018754299577
40260108	4026 8	Verstelbare moersleutel max.m. 30mm L.207mm	4018754299584
40260110	4026 10	Verstelbare moersleutel max.m. 34mm L.259mm	4018754299591
40260112	4026 12	Verstelbare moersleutel max.m. 39mm L.311mm	4018754299607
40260115	4026 15	Verstelbare moersleutel max.m. 44mm L.386mm	4018754299614
40260118	4026 18	Verstelbare moersleutel max.m. 53mm L.462mm	4018754299621

GTIN-code.

