



## IMPACT-TORX® screwdriver sockets 1/2"

2307TX

Product no. 23070050  
GTIN 4018754015245  
Model 2307TX IMP T 50



**Label.** IMPACT screwdriver socket 1/2 " T50 L.40mm

- Features.**
- for recessed TORX® bolts
  - 1/2" internal square drive
  - Chrome Alloy Steel, gunmetal finish

## Product highlights.



### Optimized functionality.

All IMPACT sockets have a through cross hole for the connecting pin and a deep groove for the rubber locking ring. The locking pin is not stressed during use.

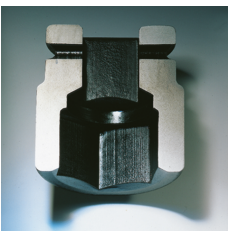

### High fitting accuracy.

The high precision fit, achieved through tight tolerances, ensures optimal, backlash-free transmission of forces to the socket.

## Technical Drawing.

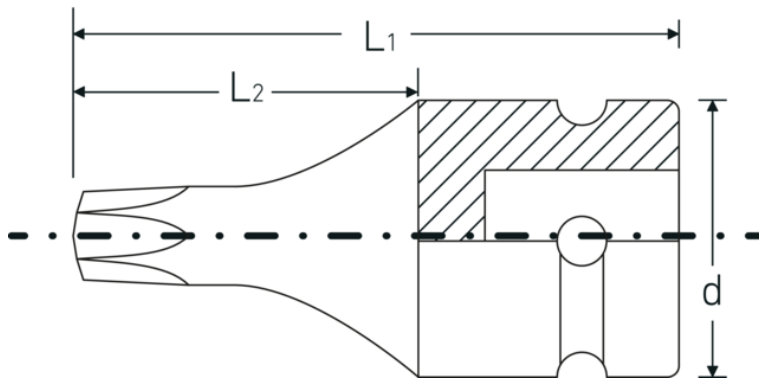

## Technical Attributes.

Drive profile	TORX®
TORX® drive profile (mm)	8,8 mm
Internal square drive (inch)	1/2 "
d	25 mm
Size of output profile	T50
L1	40 mm
L2	22 mm

## Logistics data.

Depth mm (IFS)	40
Width mm (IFS)	25
Height mm (IFS)	25
WEEE/ElektroG	nicht ear-pflichtig
Length (packed, mm)	105
Width (packed, mm)	45
Height (packed, mm)	26
Volume (packed, dm3)	0.12285 dm3
Product no.	23070050
Weight (gross, kg)	0,291
Weight PAP (kg)	0,000
Weight PVC (kg)	0,005
GTIN	4018754015245
Country of origin AWR	GERMANY
Region of origin	Nordrhein-Westfalen
Customs tariff no.	82042000
Packing standard	5
Weight	57 g

## Variants.

Product no.	Model no. (ERP)	Description	GTIN
23070030	2307TX IMP T 30	IMPACT screwdriver socket 1/2 " T30 L.40mm	4018754015221
23070040	2307TX IMP T 40	IMPACT screwdriver socket 1/2 " T40 L.40mm	4018754015238
23070045	2307TX IMP T 45	IMPACT screwdriver socket 1/2 " T45 L.40mm	4018754154012

23070050	2307TX IMP T 50	IMPACT screwdriver socket 1/2 " T50 L.40mm	4018754015245
23070055	2307TX IMP T 55	IMPACT screwdriver socket 1/2 " T55 L.40mm	4018754015252
23070060	2307TX IMP T 60	IMPACT screwdriver socket 1/2 " T60 L.40mm	4018754015269

## GTIN-Code.



## Accessories.



39022030  
IMPACT locking pin



39011940  
Rubber rings