



Open-ended striking wrench

4204



Product no. **42040055**
GTIN **4018754023721**
Model **4204 55**

Label. Open-ended striking wrench Wrench size 55mm L.300mm

Technical Drawing.

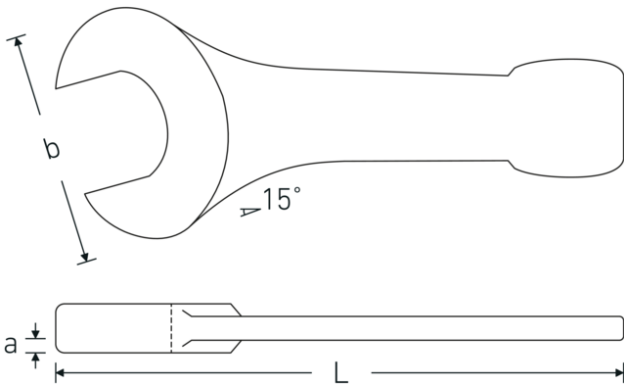

Technical Attributes.

a	23 mm
Width mm (b)	116 mm
DIN	DIN 133
Length mm (L)	300 mm
Wrench width 1 [mm]	55 mm

Logistics data.

Depth mm (IFS)	298
Width mm (IFS)	116
Height mm (IFS)	26
Length (packed, mm)	298
Width (packed, mm)	116
Height (packed, mm)	26
Volume (packed, dm3)	0.898768 dm3
Product no.	42040055
Weight (gross, kg)	2,057

Weight PAP (kg)	0,000
Weight PVC (kg)	0,000
GTIN	4018754023721
Country of origin AWR	GERMANY
Region of origin	Nordrhein-Westfalen
WEEE/ElektroG	nicht ear-pflichtig
Customs tariff no.	82041100
Packing standard	1
Weight	2057 g

Variants.

Product no.	Model no. (ERP)	Description	GTIN
42040027	4204 27	Open-ended striking wrench Wrench size 27mm L.180mm	4018754023653
42040030	4204 30	Open-ended striking wrench Wrench size 30mm L.190mm	4018754023660
42040032	4204 32	Open-ended striking wrench Wrench size 32mm L.190mm	4018754023677
42040036	4204 36	Open-ended striking wrench Wrench size 36mm L.215mm	4018754023684
42040041	4204 41	Open-ended striking wrench Wrench size 41mm L.235mm	4018754023691
42040046	4204 46	Open-ended striking wrench Wrench size 46mm L.255mm	4018754023707
42040050	4204 50	Open-ended striking wrench Wrench size 50mm L.275mm	4018754023714
42040055	4204 55	Open-ended striking wrench Wrench size 55mm L.300mm	4018754023721
42040060	4204 60	Open-ended striking wrench Wrench size 60mm L.320mm	4018754023738
42040065	4204 65	Open-ended striking wrench Wrench size 65mm L.342mm	4018754023745
42040070	4204 70	Open-ended striking wrench Wrench size 70mm L.375mm	4018754023752
42040075	4204 75	Open-ended striking wrench Wrench size 75mm L.375mm	4018754023769
42040080	4204 80	Open-ended striking wrench Wrench size 80mm L.408mm	4018754023776
42040085	4204 85	Open-ended striking wrench Wrench size 85mm L.408mm	4018754023783
42040090	4204 90	Open-ended striking wrench Wrench size 90mm L.445mm	4018754023790

42040095	4204 95	Open-ended striking wrench Wrench size 95mm L.445mm	4018754023806
42040100	4204 100	Open-ended striking wrench Wrench size 100mm L.485mm	4018754023813
42040105	4204 105	Open-ended striking wrench Wrench size 105mm L.485mm	4018754023820

GTIN-Code.

