



IMPACT socket

50IMP

Product no. **23010012**
GTIN **4018754233748**
Model **50 IMP 12**



Label. IMPACT socket 1/2" 12mm L.38mm

- Features.**
- with hex
 - 1/2" internal square drive
 - DIN 3129 / ISO 1711-2
 - Chrome Alloy Steel, gunmetal finish

Advantages.

1/2" internal square drive.

Product highlights.



Powerful and resilient.

The sockets are made from high-quality Chrome Alloy Steel. They are hardened in oil to prevent stress and distortion.



Optimized functionality.

All IMPACT sockets have a through cross hole for the connecting pin and a deep groove for the rubber locking ring. The locking pin is not stressed during use.



High fitting accuracy.

The high precision fit, achieved through tight tolerances, ensures optimal, backlash-free transmission of forces to the socket.

Technical Drawing.

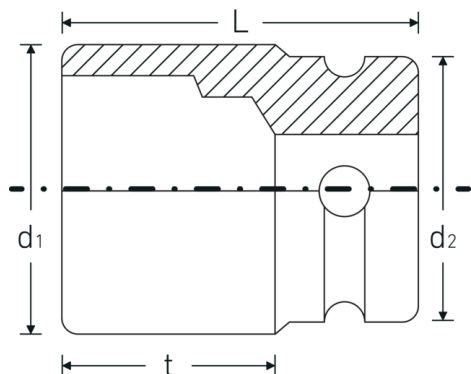

Technical Attributes.

| | |
|------------------------------|-----------------------|
| Drive profile | hex |
| Internal square drive (inch) | 1/2 " |
| d1 | 19,5 mm |
| d2 | 25 mm |
| DIN | DIN 3129 / ISO 1711-2 |
| Length mm (L) | 38 mm |
| Width across flats [mm] | 12 mm |
| t | 21,5 mm |

Logistics data.

| | |
|-----------------------|---------------------|
| Depth mm (IFS) | 32 |
| Width mm (IFS) | 24 |
| Height mm (IFS) | 24 |
| Length (packed, mm) | 150 |
| Width (packed, mm) | 90 |
| Height (packed, mm) | 25 |
| Volume (packed, dm3) | 0.3375 dm3 |
| Product no. | 23010012 |
| Weight (gross, kg) | 0,885 |
| Weight PAP (kg) | 0,000 |
| Weight PVC (kg) | 0,004 |
| GTIN | 4018754233748 |
| Country of origin AWR | GERMANY |
| Region of origin | Nordrhein-Westfalen |
| WEEE/ElektroG | nicht ear-pflichtig |
| Customs tariff no. | 82042000 |
| Packing standard | 10 |
| Weight | 88 g |

Variants.

| Product no. | Model no. (ERP) | Description | GTIN |
|-------------|-----------------|---------------------------------|---------------|
| 23010008 | 50 IMP 8 | IMPACT socket 1/2 " 8mm L.38mm | 4018754233731 |
| 23010010 | 50 IMP 10 | IMPACT socket 1/2 " 10mm L.38mm | 4018754014958 |
| 23010011 | 50 IMP 11 | IMPACT socket 1/2 " 11mm L.38mm | 4018754014965 |
| 23010012 | 50 IMP 12 | IMPACT socket 1/2 " 12mm L.38mm | 4018754233748 |
| 23010013 | 50 IMP 13 | IMPACT socket 1/2 " 13mm L.38mm | 4018754014989 |
| 23010014 | 50 IMP 14 | IMPACT socket 1/2 " 14mm L.38mm | 4018754014996 |
| 23010015 | 50 IMP 15 | IMPACT socket 1/2 " 15mm L.38mm | 4018754015009 |
| 23010016 | 50 IMP 16 | IMPACT socket 1/2 " 16mm L.38mm | 4018754015016 |
| 23010017 | 50 IMP 17 | IMPACT socket 1/2 " 17mm L.38mm | 4018754015023 |
| 23010018 | 50 IMP 18 | IMPACT socket 1/2 " 18mm L.38mm | 4018754015030 |
| 23010019 | 50 IMP 19 | IMPACT socket 1/2 " 19mm L.40mm | 4018754015047 |
| 23010021 | 50 IMP 21 | IMPACT socket 1/2 " 21mm L.40mm | 4018754015061 |
| 23010022 | 50 IMP 22 | IMPACT socket 1/2 " 22mm L.42mm | 4018754015078 |
| 23010023 | 50 IMP 23 | IMPACT socket 1/2 " 23mm L.40mm | 4018754233755 |
| 23010024 | 50 IMP 24 | IMPACT socket 1/2 " 24mm L.44mm | 4018754015092 |
| 23010025 | 50 IMP 25 | IMPACT socket 1/2 " 25mm L.44mm | 4018754233762 |
| 23010027 | 50 IMP 27 | IMPACT socket 1/2 " 27mm L.45mm | 4018754015122 |
| 23010030 | 50 IMP 30 | IMPACT socket 1/2 " 30mm L.50mm | 4018754233779 |
| 23010032 | 50 IMP 32 | IMPACT socket 1/2 " 32mm L.50mm | 4018754233786 |

GTIN-Code.



Accessories.



39022030
Connecting pin



39011940
Rubber rings